

Making Table Wine at Home

The Authors

George M. Cooke is Extension Enologist,
Department of Viticulture and Enology,
University of California, Davis,
and James T. Lapsley is a
Continuing Education Specialist,
University Extension, also at Davis.

For information about ordering this publication, write to:

Publications
Division of Agriculture and Natural Resources
University of California
6701 San Pablo Avenue
Oakland, California 94608-1239
or telephone (415) 642-2431

Publication 21434
ISBN 0-931876-80-X
Library of Congress Catalog Card Number 87-71575

© 1988 by The Regents of the University of California
Division of Agriculture and Natural Resources.

All rights reserved.

No part of this publication may be reproduced, stored in a retrieval system, or transmitted, in any form or by any means, electronic, mechanical, photocopying, recording, or otherwise, without the written permission of the publisher and the authors.

Printed in the United States of America.

To simplify information, trade names of products have been used. No endorsement of named products is intended, nor is criticism implied of similar products which are not mentioned.

The University of California, in compliance with the Civil Rights Act of 1964, Title IX of the Education Amendments of 1972, and the Rehabilitation Act of 1973, does not discriminate on the basis of race, creed, religion, color, national origin, sex, or mental or physical handicap in any of its programs or activities, or with respect to any of its employment policies, practices, or procedures. The University of California does not discriminate on the basis of age, ancestry, sexual orientation, marital status, citizenship, medical condition (as defined in section 12926 of the California Government Code), nor because individuals are disabled or Vietnam era veterans. Inquiries regarding this policy may be directed to the Personnel Studies and Affirmative Action Manager, Division of Agriculture and Natural Resources, 2120 University Avenue, University of California, Berkeley, California 94720, (415) 644-4270.

5m-pr-2/88-HS/FB

Contents



	<i>Introduction</i>	1
1.	<i>Overview of Wine Making</i>	3
2.	<i>Composition and Quality of Grapes and Wine</i>	4
3.	<i>Making Red Table Wines</i>	7
	Crushing and stemming	
	Adding sulfur dioxide	
	Adding pure wine yeast starter cultures	
	Alcoholic fermentation	
	Pressing	
	Malolactic fermentation	
	Completing alcoholic fermentation	
	Racking	
	Aging and topping	
	Bottling	
	Making rosé or pink table wines	
4.	<i>Making White Table Wines</i>	18
	Crushing, stemming, and pressing	
	Adding sulfur dioxide, settling, adding yeast, and fermentation	
	Racking, topping, aging, and bottling	
5.	<i>Potential Spoilage and Stability Problems</i>	22
	Acetification and oxidation	
	Hydrogen sulfide (H ₂ S)	
	Cloudiness and deposits	
	Other clarifying and fining agents	
	Wine filtration	
6.	<i>Analyzing Juice and Wine</i>	25
	Wine acidity and pH	
	Keeping records	
	Soluble solids (°Brix)	
	Reducing sugar	
	Titrateable acidity	
	Total and free sulfur dioxide	
	Malic acid	
7.	<i>Evaluating Wine Quality</i>	30
8.	<i>The Wine Making Facility</i>	32
	The processing work area	
	The wine aging and storage areas	
	Equipment and supplies	
	Cleaning and sanitizing	
	Cleaning and maintaining of wooden cooperage	
	<i>Afterword</i>	37
	<i>Helpful Sources and Information</i>	38
	Selected references	
	Sources of equipment and supplies for home wine making	
	Additional sources of information and assistance	
	Federal regulations pertinent to home wine making	
	<i>Glossary</i>	42

Acknowledgments

For many years, one of us (Cooke) recommended a technologically sound, practical, and concise 31-page booklet to anyone seeking assistance on home wine making, particularly those using *Vitis vinifera* grapes. That booklet, published in 1962, was *Wine Making at Home* by Maynard A. Amerine and George L. Marsh, and unfortunately it is now out of print and no longer available. This publication owes a great deal to that well written, useful work. We also acknowledge the following books as rich, technical resources: *The Technology of Wine Making*; *Table Wines, The Technology of Their Production*; and *Wine, An Introduction*. They are listed in this guide under **Selected References**, along with other books, bulletins, and pamphlets.

The authors also appreciate and recognize the extensive knowledge they have gained over the years through lectures and personal communication with the faculty of the Department of Viticulture and Enology, University of California, Davis, notably Professors Roger B. Boulton, Ralph E. Kunkee, Cornelius S. Ough, Vernon L. Singleton, and A. Dinsmoor Webb. Finally, we are particularly indebted to Peter Brehm, John Daume, and Desmond Lundy for their insightful guidance regarding wine making equipment and supplies, and to the reviewers of this publication for their time and helpful advice.

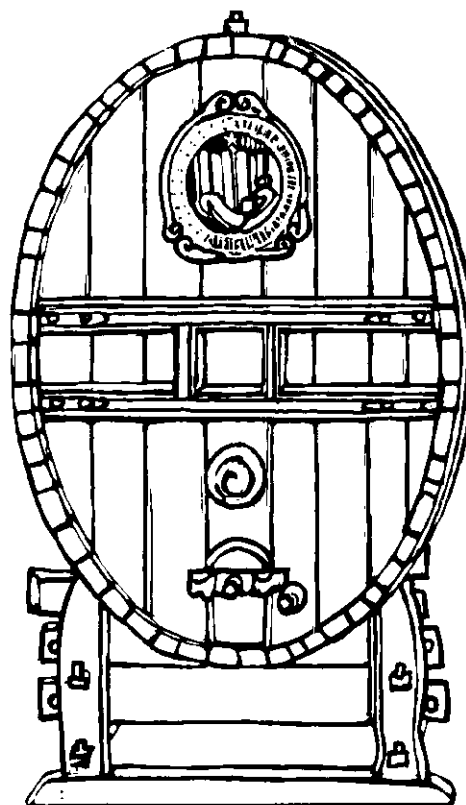

Introduction

Grapes are unique among fruits. Ripe, they contain sufficient sugar and an appropriate amount of acid so that when they ferment enough alcohol is produced to make a palatable wine that is protected against imminent spoilage. Other fruits do not possess the proper balance of these basic constituents. Hence, sugar, acid, or water, or sometimes a combination of them must be added prior to fermentation. Otherwise, inadequate or excessive alcohol may be formed, fermentations may stick, and the product could either be so acidic (tart) or so flat that it would taste unpleasant or insipid. Minor adjustments in sugar and acid content of *vinifera* grapes may sometimes be required, but not often. On the other hand, other fruits almost always require additional steps in preparing and handling the raw material that don't apply to making grape wine. Hence, this publication is confined to grape wines.

The two major kinds of grapes used in the production of grape wines are native American species of grapes, or hybrids thereof, and the European species or *Vitis vinifera*. A well known American grape species is *Vitis labrusca*; many varieties are cultivated in the eastern United States, especially in New York. *Labrusca* varieties include Concord, Delaware, Niagara, Catawba, and Ives Seedling. To varying degrees, these grapes and the wines made from them have a noticeable aroma, commonly referred to as "foxy," that is partially due to the presence of the compound methyl anthranilate. Primarily, this

characteristic distinguishes these wines from those produced elsewhere, particularly in western Europe and California. Besides their distinct aroma, these native grape varieties generally contain insufficient sugar to produce a balanced table wine. Thus, in eastern wine making adding sugar or chaptalization is permitted. These grapes also have other compositional and physical characteristics that require specialized handling methods. Because of these factors, as well as the more extensive interest in *vinifera* wines, the making of wine from American grape species will not be covered here. However, for those interested in making wine from American grapes, we highly recommend *Grapes into Wine* by P. M. Wagner (see Selected References).

Wine types are usually divided into classes according to their alcoholic content, groupings that form a convenient basis for excise taxes upon alcohol. The two major classes are table wines (9 to 14 percent alcohol) and dessert and appetizer wines (15 to 21 percent alcohol). Table wines owe their alcoholic content to the fermentation of sugar naturally present in the grapes and to the sugar that may be added to them. On the other hand, dessert wines obtain their higher alcoholic content from the addition of alcohol (wine spirits). Demand for table wine in the U.S. far exceeds that for dessert wine and because demand for information on home wine making has centered on making table wine, this publication is about grape table wine only.

Tax-free production of limited quantities of wine at home was allowed for many years in the United States, even during Prohibition. Despite this apparent legal freedom, laws and regulations pertaining to home wine making contained several arbitrary restraints that led to confusion and inconvenience. In 1979, these regulations were liberalized to permit home wine making without requiring registration. Details of the new regulations are given at the end of this publication.

Although no published figures exist on the volume of homemade wine produced in the U.S. annually, most observers agree that it probably exceeds 10 million gallons. Along with increased wine consumption since 1970, an "explosion" in the demand for information about grapes and wine has occurred in the United States. Not only has California's grape and wine industry experienced rapid growth, but a grape and wine growing renaissance has occurred in more than 40 other states as well. In California, the number of bonded wineries, mostly small table wine operations located primarily in coastal areas and the foothills, now total over 650. Many new winery entrepreneurs began their ventures as home winemakers.

In response to widespread interest, this guide covers the fundamentals of making table wine that should provide the basis for more successes than failures. Making your own wine can be an enjoyable, enriching, and

rewarding experience. The ability to consistently make sound, above average, quality wines requires not only the desire to succeed, but, at times, hard work, patience, and attention to detail.

Aside from motivation and adherence to details, two other factors can influence the successful production of table wine at home: the amount to be produced and the kind of raw material used. While a few gallons of sound, palatable wine can be made easily from reconstituted grape concentrate, producing a fine quality wine is more readily realized from larger lots, using fresh, ripe grapes. Successful production of just 5 to 10 gallons of wine from small quantities of grapes requires considerable technical skill, experience, and the proper equipment, owing to the larger surface-to-volume ratio inherent in small volumes. Working with larger quantities of grapes and larger wine volumes minimizes chances of spoilage and oxidation. Thus, we recommend working with a minimum of about ½ ton of grapes to produce about 50 gallons of finished wine. Although these guidelines are presented with these factors in mind, the principles covered apply equally to smaller wine making activities. As a matter of fact, many beginners may wish to start out with one or two 5- to 10-gallon fermentations of reconstituted grape concentrate to become familiar with alcoholic fermentation, the adding of yeast and sulfur dioxide, and other wine making steps.

1

Overview of Wine Making

Ten processing operations are common to making white and red table wines. However, they are not all performed in the same order:

1. **Stemming and crushing.** Stems are separated from grape berries, the skins of which are broken to free the juice. The mixture of juice, skins, seeds, and pulp is called must.
2. **Determining sugar and acidity of the juice.** Sugar content is approximately equal to percent soluble solids (° Brix).
3. **Adding sulfur dioxide (SO₂).** Needed to inhibit growth of spoilage organisms and prevent oxidation.
4. **Adding pure wine yeast starter cultures.** Facilitates a clean, consistent, and complete fermentation.
5. **Pressing.** Skins and seeds are separated from the juice at the beginning in the case of white wine and after some fermentation on the skins in the case of red.
6. **Fermenting.** Yeast converts sugar to alcohol and carbon dioxide.
7. **Racking wine from lees.** The clear wine is separated from spent yeast cells and other solids after fermentation.
8. **Adjusting SO₂ content.** Prevents spoilage and oxidation.
9. **Aging/topping and/or clarification.**
10. **Bottling.**

These 10 wine making steps may appear relatively easy to the experienced winemaker. The inexperienced winemaker, however, must learn to check details, such as topping in a timely manner, using a pure yeast wine starter culture, or properly using SO₂, to avoid wine spoilage. For several reasons, good quality red table wines are easier for the beginner to make than are white wines, mostly because white wines are more subject to oxidation and browning. Therefore, start with red table wines to gain experience.

The major difference between red and white wines is that, after stemming and crushing, the juice of the must for red wines is fermented on the skins for several days to extract their red pigments. In white wines, only the clear juice is fermented to minimize extraction of tannins from skins and seeds. Other significant differences:

1. White wines should be fermented at cooler temperatures than are reds to achieve the best quality.
2. Red wines gain in quality and complexity by aging in oak barrels.
3. White wines generally are made without wood aging and are consumed when they are relatively young; thus, they retain fresh and fruity aromas and flavors.

For both red and white wines the volume of wine made must be larger than the total storage capacity of the aging or storage containers—glass carboys, gallon jugs, or barrels—because additional wine will be needed to replace the volume lost to lees after fermentation, and for topping during aging to replace wine lost to ullage or evaporation. (See sections on racking and aging of red wines.)

2

Composition and Quality of Grapes and Wine

The home winemaker has a choice of three raw materials for wine: freshly picked grapes, grape juice concentrate, or frozen must or juice. Of the three, it is generally recognized that the first offers the greatest quality potential and the second offers the most convenience. Both red and white grape juice concentrate is available from most vendors of home wine making supplies and is readily reconstituted by diluting with water. Follow the suppliers' directions to obtain juice of the desired strength. Varietal concentrate or the concentrated juice of different wine grape varieties is also available for home wine making. A few firms in California sell fresh frozen *vinifera* varietal grape must or juice. Limited evaluations suggest that wines made from frozen juice or must can be of acceptable quality when compared with wines made from fresh grapes. The obvious advantage to making wines from reconstituted grape concentrate or frozen must or juice is that they can be made at times other than the usual fall grape harvest.

The best raw material: fresh grapes

Fresh, ripe, varietal wine grapes remain the best raw material for making wine. Some home wine shops will accept orders for fresh varietal *vinifera* grapes before the harvest season. Home winemakers located near California's many coastal and foothill vineyards can purchase fresh wine grapes directly from a grower or from growers through wine grape grower associations. Growers can also be contacted through many University of California Cooperative Extension county farm advisor offices. A description of wine grape varieties, including usual harvest period, may be found in UC Publication 4069 (see Selected References). Place orders and make arrangements for delivery or pickup 3 months in advance (usually in June) to insure getting the quantity of each varietal desired.

In planning grape purchases, be aware that many growers who sell small quantities of grapes for home wine making pick into lug boxes that hold about 50



pounds of grapes each. Thus, 1 ton of grapes will require 40 boxes. Some growers may require a deposit for the lug boxes or you may have to provide your own picking containers. Make this arrangement at the time of your order; always return lug boxes clean and dry; large plastic tubs can be substituted for wooden boxes. Depending upon the variety and other factors, the home winemaker can usually expect that 1 ton of grapes for white wine will yield about 100 to 120 gallons of wine; 1 ton of red wine grapes will yield about 120 to 150 gallons of wine (the more press wine used, the higher the yield).

Aside from the form of raw material itself, several important factors influence wine quality. Foremost: Good wines can only be made from good grapes! Grape quality is directly related to the composition of the fruit when it is harvested. In turn, grape composition is influenced by climate. Premium wine grape varieties, such as Chardonnay, White Riesling, Gewürztraminer, Pinot noir, and Cabernet Sauvignon, are obtained from the cooler north, central, and south coastal California counties. Many foothill vineyards, as in California's Amador and El Dorado counties, yield good quality Zinfandel, Sauvignon blanc, French Colombard, Chenin blanc, Petite Sirah, and Barbera. Extensive research concludes that climate is the single most important factor affecting the composition and quality of California's wine grapes and hence the composition and quality of its wines. Specifically, in cooler climates, more grape acids, varietal grape aroma, and flavor compounds develop and, in the case of red

Table 1. Desired sugar, acidity, and pH levels in ripe wine grapes

Wine type	Optimum sugar	Titratable acidity*	pH [†]
White wine grapes	20.5–22° Brix [‡]	8–10 g/L	3.2–3.4
Red wine grapes	22.5–24.5° Brix	6–8 g/L	3.3–3.5

*Values expressed as g tartaric acid per l.

[†]A measure of free hydrogen (acid) ions in a solution

[‡]A measurement of soluble solids, roughly equal to percent sugar content.

types, tannins and color are retained at higher, more desirable levels. These compounds are directly related to wine quality. Table 1 shows the amounts of certain components of white and red wine grapes that are generally considered to be desirable for good quality wines.

Of interest to the winemaker are these major grape components: grape sugars, organic acids, aroma and flavor compounds, polyphenolic compounds or tannins, certain amino acids, and certain metallic ions, such as potassium. Fully mature or ripe grapes contain about an equal concentration of glucose and fructose, which are the simple sugars yeast ferment to form alcohol and carbon dioxide. Ripe grapes contain from 70 to 80 percent water by weight.

Depending upon the variety, the predominant organic acids in grapes are tartaric and malic acids. In addition to their contribution to the flavor and balance of wine, tartaric acid is involved in wine stability, while malic acid is involved in the malolactic fermentation (see **Glossary**). The complex nature of grapes and wine has been verified by the isolation and identification of more than 400 aroma and flavor compounds present. Such polyphenolic compounds as tannins are also important to wine flavor, stability, and aging, particularly in red wines. Certain amino acids have been shown to influence wine quality, but they are perhaps more important as a source of nitrogen for yeast cell metabolism. Such metallic ions as potassium are constituents important in wine quality and stability. Finally, while the individual and combined interactions and contributions of these grape and wine components to wine quality are complex, they become more understandable with study and experience.

Because climate or other factors are unreliable, it is not always possible to obtain grapes with optimal sugar, acid, and pH. Fortunately, home winemakers are not hampered by both the federal and state regulations that control amelioration in commercial wine making. Sugar levels that exceed 25° Brix can be lowered by adding water, to avoid difficulty with fermentation. The fermentation may even stop before dryness, resulting in incomplete fermentation. However, adding water to reduce a must's sugar content will also lower its acidity;

Which variety to select?

Distinctiveness or intensity of grape aroma varies widely between varieties of *Vitis vinifera* and within a variety depending upon climate, ripeness of the grapes, crop size, and other factors. Below is a listing of some well known and important varieties grouped according to their potential intensity of varietal aroma:

Distinctive white wine types. Muscat blanc (Muscat Canelli, Muscat Frontignan), Muscat of Alexandria, Orange Muscat, Symphony, White Riesling (Johannisberg Riesling), Chardonnay, Sauvignon blanc, Semillon, Emerald Riesling, Gewürztraminer, Sylvaner, Grey Riesling, Pinot blanc, Chenin blanc

Distinctive red wine types. Cabernet Sauvignon, Carmine, Barbera, Centurion, Pinot noir (Gamay Beaujolais), Merlot, Nebbiolo, Zinfandel, Ruby Cabernet, Grenache, Carnelian, Petite Sirah (Durif), Napa Gamay

Nondistinctive white wine types. Aligote, Burger, Thompson Seedless, Colombard (French Colombard), Green Hungarian, Palomino

Nondistinctive red wine types. Carignane, Mission, Charbono, Emperor, Flame Tokay, Refosco, Red Malaga, Valdepeñas

such a change would be undesirable in a must already deficient in acidity. Thus, there are three options:

1. Ferment without adjustment.
2. Blend before fermentation with juice or must of the same variety that has moderate sugar and high acidity.
3. Before fermentation add water to lower sugar content and raise acidity to taste immediately after fermentation.

A must seriously deficient in acidity may also require acid addition before fermentation. Selection of the most suitable action will vary according to each lot and the winemaker's objectives.

Must or juice sugar and acid that fall well below levels shown in table 1 should be adjusted. A useful rule of thumb: To produce a wine of about 12 percent alcohol, the must or juice should be between 22° to 24° Brix. Sugar is increased by adding cane or beet sugar (sucrose). Use the following formula to calculate the amount of sugar to add to increase the °Brix:

$$S = W \times \frac{B - A}{(100 - B)}$$

where, S = weight of sugar to be added to increase must or juice to a desired °Brix

W = weight of grape must

B = desired °Brix

A = original °Brix of grape must

For example, if you want to raise the °Brix of 10 pounds of juice or must from 15 to 23, calculate the amount of sugar required as:

$$S = 10 \times \frac{23 - 15}{(100 - 23)} = 1.04 \text{ lb}$$

It should be apparent that large amounts of 15° Brix juice require proportionately larger quantities of sugar to raise the °Brix to the desired level. For example, 10.4 and 104 pounds of sugar would be needed to increase the °Brix from 15° to 23° with, respectively, 100 and 1,000 pounds of must or juice. Considering the high cost of sugar, riper grapes are obviously preferable.

A less accurate method for raising the sugar content by 1° Brix is to add 1.25 pounds sugar to each 10 gallons of juice or must.

Deficiencies in total acidity can be corrected similarly. Table 2 gives the amounts in grams (g) of tartaric acid that must be added to each gallon (gal) of must or juice to increase the titratable acidity (TA) from a given low level to either 6 or 8 g per liter (L). A TA of 6 g/L is considered a minimal acid level and a TA of 8 g/L is optimal acidity, especially for white wine. For example, to increase the TA of a Zinfandel must from 5 to 6 g/L, 38 g (1.33 oz) tartaric acid are required for each 10 gal of must. Metric units, such as grams, are readily converted to other units of measure using the adjacent Conversion Factors chart (table 3).

Table 2. Amounts of tartaric acid required to increase acidity

Present acid content	To obtain 6.0 g/L add to each gal:	To obtain 8.0 g/L add to each gal:
(g/L)*	(g)	(g)
3.0	11.3	18.9
3.5	9.4	17.0
4.0	7.5	15.2
4.5	5.6	13.2
5.0	3.8	11.4
5.5	1.9	9.5
6.0		7.5
6.5		5.6
7.0		3.8
7.5		1.9

*Titratable acidity as tartaric acid.

Table 3. Conversion factors

To convert from	To	Multiply by
Acres	hectares	0.4047
Cups	ounces	8.0
Cups	milliliters	236.6
Drams	milliliters	3.7
Gallons	liters	3.79
Grams	milligrams	1000
Grams	ounces	0.035
Grams/liter	pounds/gal	8.345×10^{-3}
Hectares	acres	2.47
Hectoliters	liters	100
Kilograms	grams	1000
Kilograms	ounces	35.27
Kilograms	pounds	2.2
Liters	gallons	0.264
Liters	ounces	33.8
Liters	pints	2.11
Liters	quarts	1.06
Milligrams	grams	0.001
Milligrams	ounces	3.5×10^{-5}
Milligrams	pounds	2.2×10^{-6}
Milliliters	liters	0.001
Milliliters	ounces	0.034
Ounces	grams	28.3
Ounces	milliliters	29.57
Pints	gallon	0.125
Pints	ounces	16
Pounds	grams	453.6
Quarts	liters	0.946
Tablespoons	teaspoons	3
Tablespoons	ounces	0.5
Tablespoons	milliliters	15
Teaspoons	milliliters	5
Teaspoons	tablespoons	3

Following adjustments in sugar and/or acid content, the °Brix and/or TA should be determined again to verify that the desired adjustment has been achieved.

3

Making Red Table Wines

Figure 1 is a schematic of the basic operations involved in making red table wines. Each step is discussed below. Additional information, not depicted in the schematic drawing, is also presented.

Crushing and stemming

This first step may be performed by hand or by machine. For handling a ton or more of grapes, use a mechanical crusher-stemmer. Examples of these devices are shown in figure 2 and are detailed in Chapter 8 in the section on equipment and supplies. Using a small crusher-stemmer, two persons can crush and stem a ton of grapes in about 1 hour. Smaller lots of grapes can be

crushed, using a hand-operated, roller-type crusher. In either case, to collect the crushed grapes (must), the machine is placed and supported above a container, such as a large polyethylene plastic tub or garbage can. If only a crusher is used, place chicken wire over the collecting container to separate out most of the stems; these are intermittently discarded, as necessary. Small, fragmented pieces of stems that get into the must will increase the wine's astringency or bitterness and their inclusion should be avoided as much as possible. The important objective is to minimize bitterness by thoroughly crushing the berries without macerating the seeds, and while recovering all of the skins and juice in the must. After stemming and crushing, the fermentors

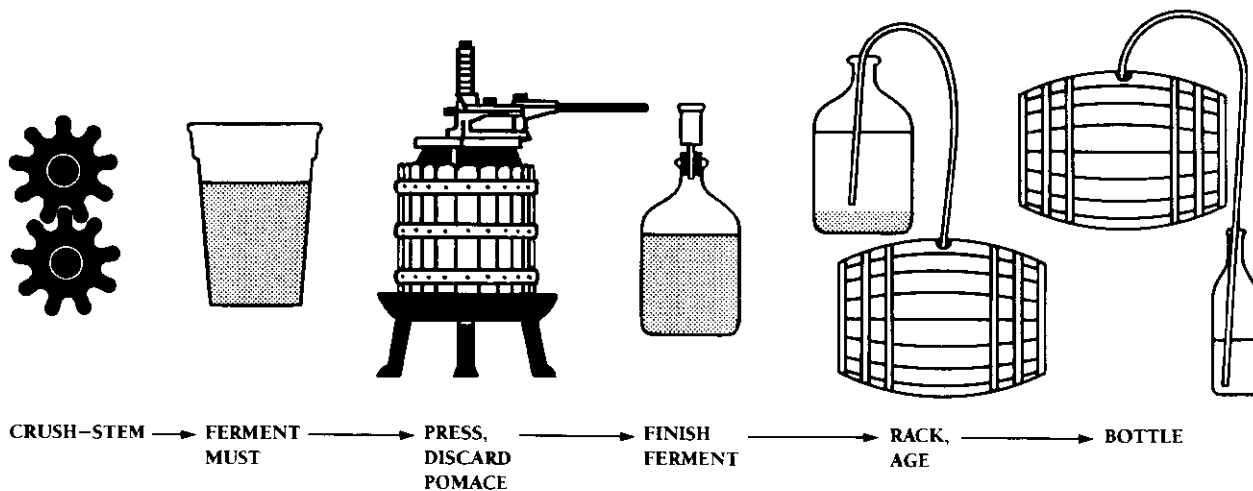

Fig. 1. Essential steps in red wine making.

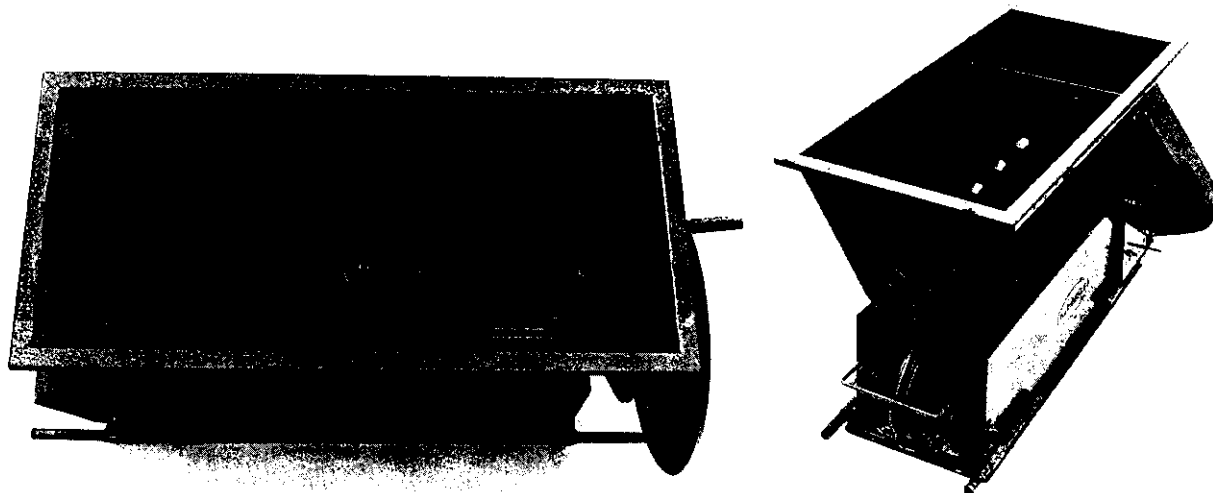

Fig. 2. *Left*, hand-operated roller-crusher; *right*, crusher-stemmer, fitted for motor drive.

are filled with the must to about two-thirds capacity, to avoid foaming-over during fermentation. Probably the most practical and least expensive fermentation vessel is a 32-gallon plastic garbage can (polyethylene plastic is preferable). About eight or nine are needed to handle a ton of crushed grapes.

After all of the must has been poured into the fermentors and sulfur dioxide has been added (see below), the fermentors should be covered with cheesecloth or plastic to keep out insects. Temperature, total soluble solids, titratable acidity, and the free and total SO_2 (note analyses section) of the must in each fermentor should be determined and the results recorded.

Adding sulfur dioxide

Sulfur dioxide (SO_2) is a chemical compound that has been used in wine making for more than a century. Because it is known that wine yeast produce small amounts of SO_2 during fermentation, SO_2 can be considered a natural constituent of wine. The amounts produced vary widely, and to insure against deficiencies, commercial wineries add small amounts to inhibit development of such spoilage microorganisms as vinegar bacteria and spoilage yeast, and to prevent oxidation and browning. Although SO_2 has proved an effective wine preservative, its use, as with other food additives, has been brought into question. Despite 75 years of enological research, no satisfactory alternative practice has been found for preventing microbial spoilage and oxidation of wine. In reaction to reports that suggested that a very small number of asthmatics ran a potential risk if they consumed wine containing SO_2 , new federal regulations were adopted in 1986 for using SO_2 . As of January 9, 1988, whenever a wine contains 10 ppm or

more total SO_2 , the label will be required to disclose that it "contains sulfites."

Judicious and moderate use of SO_2 has long been recommended. Recent research shows that the best quality wines are made when SO_2 has been used both before and after fermentation. Some commercial winery experience indicates that use of SO_2 , before alcoholic fermentation, can be minimized or even omitted when freshly harvested grapes are free of mold, mildew, rot, or any other defects (cracked or broken skins), and these grapes are handled, throughout the wine making process, under strict sanitary conditions and in a temperature-controlled environment. These practices are more often successful in making red wines than in making whites. Furthermore, SO_2 should be added after fermentation when usual storage or aging is contemplated and most certainly at bottling to prevent oxidation.

For most home winemakers, adding SO_2 is recommended. It has been observed that the home winemaker is generally unable to achieve strict sanitation, and hence can benefit from the judicious use of SO_2 . As stated, adding a small amount inhibits development of molds, wild yeast, and undesirable bacteria, especially vinegar bacteria. For grapes free of mildew, rot, or mold, usually from 50 to 100 parts per million (ppm) is used or about 75 ppm is adequate. This mild antiseptic is commonly used in the form of potassium metabisulfite ($\text{K}_2\text{S}_2\text{O}_5$), and is available from home wine making suppliers. To obtain 75 ppm of SO_2 , add $\frac{1}{4}$ ounce (slightly less than 1 level teaspoon) to each 10 gallons of juice or must. For grapes that have appreciable amounts of moldiness, rot, or broken berries, use twice this amount of SO_2 . To add SO_2 , dissolve the metabisulfite in a small portion of the juice; then add this back to the bulk of the must to be treated and mix thoroughly. Allow this mixture to

stand about 2 hours before adding the wine yeast starter culture (see next step).

For the beginner, some precautions about using and handling SO₂ are in order. Adding too much SO₂, a common mistake, can delay onset of fermentation; excessive amounts can actually prevent it. Using too little or no SO₂ can result in the wine turning to vinegar or spoiling. Therefore, calculate and weigh SO₂ additions carefully. The K₂S₂O₅ will lose its strength after being opened and during subsequent storage and openings, especially if it gets damp. Therefore, purchase only enough for one season's use and store tightly closed in a cool, dry place. As with other chemicals, avoid skin and eye contact, wear protective gloves, and wash hands thoroughly after use.

Finally, because wine making at home is a batch operation, it is a relatively slow process. Hence, during crushing and stemming, small portions of juice or must may be obtained over several hours. With this in mind, we recommend adding SO₂ in increments during crushing and stemming rather than after this operation has been completed. Thus, as each 10 gallons of juice or must is obtained, add SO₂ to insure its thorough distribution in the final mixture and to prevent oxidation during crushing.

As mentioned, accurate measurement of SO₂ is critical. Because repeated weighings of K₂S₂O₅ are tedious and can cause error, use a concentrated SO₂ stock solution of known strength. A 10 percent solution of K₂S₂O₅ (containing about 6 percent available SO₂) is readily prepared and convenient. Remember, however: The solution loses its strength upon repeated opening and should be replaced with a fresh solution after 1 to 2 weeks.

Depending upon amounts of must or wine to be treated, the stock solution volumes involved can be quite small and need to be measured in metric units, that is, milliliters (ml).

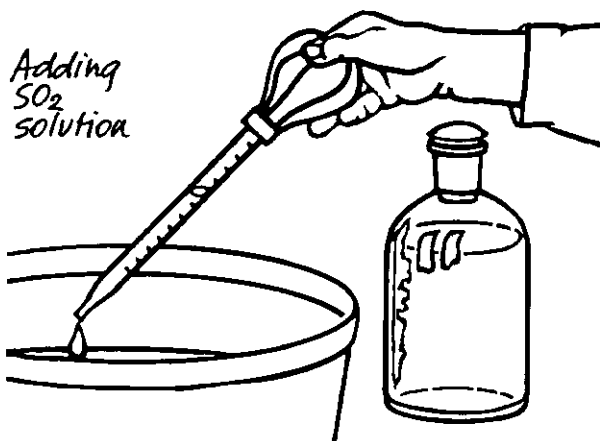

To prepare and use the 10 percent stock solution of K₂S₂O₅, the following supplies are needed:

Several sizes of graduated cylinders—10, 100, and 1,000 ml (1 liter); 1-ml and 10-ml transfer pipettes (the 1-ml pipette must be graduated in 0.01-ml intervals); and a 1-liter (L) glass reagent bottle that can be tightly stoppered with a tapered rubber or cork stopper. The solution is made by carefully weighing out 100 grams (g) (3.52 ounces [oz]) of potassium metabisulfite, and dissolving in 1 L of water. The purity of the K₂S₂O₅ should be noted on the label and if it is less than 100 percent, compensate for this difference by an appropriate adjustment to the amount weighed. For example, if the label on the K₂S₂O₅ container indicates its purity to be 96.4 percent, then 103.7 g (3.65 oz) K₂S₂O₅ is required for a 10 percent solution (100 g divided by 0.964 = 103.7 g). Dissolve the K₂S₂O₅ in 1 L of water and place in the reagent bottle, stopper tightly, label contents, and store in a cool place.

Table 4 shows the various volumes in ml of the stock solution required for final concentrations of SO₂ at given volumes of juice or wine. Sulfur dioxide solutions volatilize readily and the vapors can seriously irritate eyes, nose, throat, and lungs. Therefore, when dispensing aliquots of the K₂S₂O₅ stock solution avoid breathing the fumes, use in a well-ventilated area, and wear a fume-type face mask if you are especially sensitive. It may be helpful to position a fan so that the fumes are blown away from your face or work with the SO₂ solution outdoors. All measurements of small volumes that require use of pipettes should be done with a rubber bulb to supply suction. **Never use your mouth!**

Table 4. Making SO₂ stock solution additions

Must/wine	Desired final SO ₂ concentration (ppm)*							
	10	20	25	30	40	50	75	100
(gal)	Add ml of 10% stock solution							
1/10	.07	.13	.16	.20	.26	.33	.49	.65
1/5	.13	.26	.33	.39	.53	.66	.99	1.3
1/2	.33	.66	.82	.99	1.3	1.6	2.5	3.3
1	.66	1.3	1.6	2.0	2.6	3.3	4.9	6.6
2	1.3	2.6	3.3	3.9	5.3	6.6	9.9	13.1
3	2.0	3.9	4.9	5.9	7.9	9.9	14.8	19.7
4	2.6	5.3	6.6	7.9	10.5	13.1	19.7	26.3
5	3.3	6.6	8.2	9.9	13.1	16.4	24.6	32.9
10	6.6	13.1	16.4	19.7	26.3	32.9	49.3	65.7
25	16.4	32.9	41.1	49.3	65.7	82.1	123.2	164.3
50	32.9	65.7	82.1	98.6	131.4	164.3	264.4	328.6

*The volumes indicated assume 100 percent purity of the potassium metabisulfite (K₂S₂O₅) and full strength of the stock solution.

Adding pure wine yeast starter cultures

The use of pure wine yeast starter cultures to promote alcoholic fermentation is practiced widely in commercial wine making and is recommended for the home winemaker. The active dry form of wine yeast is available from home wine shops. Of two strains commonly used, Montrachet and Champagne, avoid Montrachet if the grapes were sulfured a few weeks before harvest, as this strain readily produces hydrogen sulfide when residual sulfur is present. Usually, two 5-gram packets of dry yeast pellets, sprinkled on the must surface with mixing, provide an adequate inoculum for each 10 gallons of must. If the must is highly sulfited, or it is difficult to start fermentation, use twice this amount of yeast. For best results, the yeast should be rehydrated before use. If rehydration is not followed precisely, yeast activity will be reduced. Therefore, we do not recommend it for very small lots.

To rehydrate, add 1 kilogram of dry yeast pellets to about 2 gallons of water or must previously warmed to 100° to 105°F (38° to 41°C). After 10 to 20 minutes, mix well and use 25.6 oz of this mixture to inoculate each 100 gal of must. This is approximately equivalent to an inoculation rate of 1 g yeast per gal of must. Note that higher temperatures, lower temperatures, and prolonged soaking in water, even at the correct temperature, can all reduce yeast activity.

Some winemakers prefer to acclimatize the yeast by first growing it in juice or sweetened diluted wine until about one-half of the sugar has fermented. This actively fermenting mixture of yeast cells is then used as the inoculum.

Alcoholic fermentation

Grape wine is the alcoholic product of the fermentation of grape juice, and the essential feature of this fermentation is the conversion of the grape sugars, glucose and fructose, to ethyl alcohol (ethanol), carbon dioxide (released as a gas), and flavor components. This complex process is accomplished by living yeast cells and is illustrated in the following chemical equation:

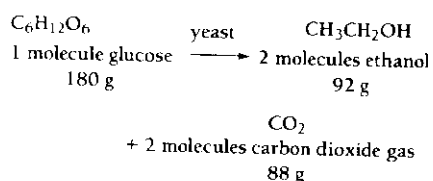

The alcohol produced through fermentation is a wine's major flavor component. It also affects the solubility of many wine constituents. Some is used in forming other flavor compounds. It also enhances wine's

resistance to spoilage. Moreover, wines traditionally are classified according to their alcoholic content. Indeed, the amount of alcohol formed from a given amount of grape sugar is of considerable practical importance to the winemaker. According to the equation above, the maximum theoretical yield of ethanol is 51.1 percent of the molecular weight of the sugar ($92/180 \times 100 = 51.1$). However, in actual practice, the alcohol yield is somewhat lower, since some sugar is utilized by the yeast for growth and for production of small amounts of other compounds. Also fermentation efficiency (ability to produce alcohol) of the yeast is not perfect or constant, and in addition some alcohol escapes with the evolution of the carbon dioxide gas. Hence, on the average, actual alcohol yields are about 47 percent by weight, instead of the 51.1 percent just shown in the previous calculation.

Given a known amount of sugar in grapes, it should be possible to estimate the amount of alcohol that can result from fermentation. Thus, a must containing 22 percent sugar by weight should yield a wine containing 10.34 percent alcohol by weight ($22 \times 0.47 = 10.34$). Note, however, that the alcoholic content of wine is expressed as percent by volume, owing to the method of its measurement. From specific gravity tables, the 10.34 percent value converts to 12.82 percent alcohol by volume.

Unfortunately, this relatively simple method cannot be used to calculate how much alcohol can be obtained from a must of a certain sugar content, as determined by the °Brix measurement. This latter term, described more fully later on, denotes the percent sugar of pure solutions. Since must or grape juice contains nonsugar-dissolved solids, the °Brix value must be corrected to give a more true percentage of the sugar content, when alcohol production is estimated. The amount of nonsugar solids has been estimated to average 3.0 percent. Thus, °Brix minus 3.0 gives the must's approximate sugar content. This value, multiplied by its specific gravity (table 5) and then multiplied by the fermentation conversion factor of 0.59 (this term represents the alcohol by volume that forms from 1 gram of sugar), will provide an estimate of the approximate percent alcohol by volume resulting from a given °Brix must.

The following example illustrates this convenient calculation: Assume that a given must or juice is 22.5° Brix. Subtracting the nonsugar correction factor of 3.0 percent, the "true" sugar content is actually 19.5 percent by weight. To convert this to percent by volume, multiply 19.5 by the specific gravity of 1.0803 (obtained from table 5). Then multiply by 0.59. The result is an approximate alcoholic content of 12.4 percent by volume.

Usually, in natural grape table wine fermentations (where no sugar is added) the alcohol produced ranges between 11 and 14 percent by volume, depending upon

initial sugar levels. In dessert and appetizer wines, such as port and sherry, alcoholic content is higher, ranging from 17 to more than 20 percent. As explained previously, this higher alcoholic content is achieved commercially by adding wine spirits.

Fermentation in wine making is not only fascinating but it is critical to success. Typically, there are three distinct stages.

1. A quiescent period of 12 to 24 hours, during which yeast cells grow and increase in sufficient numbers to commence the fermentation.
2. Vigorous activity of 2 to 3 days, during which the yeast rapidly ferments one-half to two-thirds of the sugar to alcohol and carbon dioxide gas—the later development is accompanied by frothing—and the skins rise to the surface, become compact, and form the “cap.”
3. A more or less quiet stage of relatively slow fermentation for 3 to 4 days after pressing the partially fermented juice off the skins.

Note: The rate or speed at which each event occurs depends upon fermentation temperature and amount of yeast inoculum, as well as availability of yeast nutrients. Typically, red wine fermentations take 1 to 2 weeks.

In addition to the conversion of grape sugar into alcohol and carbon dioxide, energy in the form of heat is produced, usually about 56 kilocalories per gram molecular weight of glucose fermented. Lowering or raising this heat during fermentation is essential to controlling the fermentation's progress. Within limits, the higher the temperature, the faster the fermentation rate. In red wine making, it is recommended that fermentation start at 60° to 70°F (15.6° to 21.1°C); be allowed to proceed at 75° to 80°F (23.9° to 26.7°C); and just before pressing off the skins be allowed to rise for a day or so to 85°F (29.4°C). The remainder of the fermentation should be conducted at between 68° to 70°F (20° to 21.1°C). Temperatures that reach 90° to 95°F (32.2° to 35°C) or higher can lead to a “stuck” fermentation, because at these high temperatures yeast cells die and it can be very difficult to restart fermentation. Prolonged fermentation at temperatures above 85°F (29.4°C) can create “cooked” odors and flavors. The temperatures outlined here allow for an even fermentation rate and the relatively warm conditions before pressing facilitate color extraction. Once the cap forms, the highest temperatures in the fermentor are trapped in the juice just under it.

How does the home winemaker achieve effective temperature control during fermentation? A few sample measurements will quickly indicate for each home wine making circumstance how much control is required. Unfortunately, few methods are inexpensive. Probably

Table 5. Percentage by weight (°Brix) and specific gravity (20° C./20° C) of sugar solutions*

°Brix	Specific gravity	°Brix	Specific gravity	°Brix	Specific gravity
14.0	1.0568	18.0	1.0741	22.0	1.0919
1	.0573	.1	.0746	.1	.0924
2	.0577	.2	.0750	.2	.0928
3	.0581	.3	.0755	.3	.0933
4	.0585	.4	.0759	.4	.0938
5	.0590	.5	.0763	.5	.0942
6	.0594	.6	.0768	.6	.0947
7	.0598	.7	.0772	.7	.0951
8	1.0603	.8	.0777	.8	.0956
9	.0607	.9	.0781	.9	.0960
15.0	1.0611	19.0	1.0785	23.0	1.0965
.1	.0615	.1	.0790	.1	.0969
.2	.0620	.2	.0794	.2	.0974
.3	.0624	.3	.0799	.3	.0978
.4	.0628	.4	1.0803	.4	.0983
.5	.0633	.5	.0808	.5	.0988
.6	.0637	.6	.0812	.6	.0992
.7	.0641	.7	.0816	.7	.0997
.8	.0646	.8	.0821	.8	1.1001
.9	.0650	.9	.0825	.9	1.1006
16.0	1.0654	20.0	1.0830	24.0	1.1010
.1	.0659	.1	.0834	.1	.1015
.2	.0663	.2	.0839	.2	.1020
.3	.0667	.3	.0843	.3	.1024
.4	.0672	.4	.0848	.4	.1029
.5	.0676	.5	.0852	.5	.1033
.6	.0680	.6	.0857	.6	.1038
.7	.0685	.7	.0861	.7	.1043
.8	.0689	.8	.0865	.8	.1047
.9	.0693	.9	.0870	.9	.1052
17.0	1.0698	21.0	1.0874	25.0	1.1056
.1	1.0702	.1	.0879	.1	.1061
.2	.0706	.2	.0883	.2	.1066
.3	.0711	.3	.0888	.3	.1070
.4	.0715	.4	.0892	.4	.1075
.5	.0719	.5	.0897	.5	.1080
.6	.0724	.6	1.0901	.6	.1084
.7	.0728	.7	.0906	.7	.1089
.8	.0733	.8	.0910	.8	.1093
.9	.0737	.9	.0915	.9	.1098

*Adapted from tables in: Bates, F. J., and associates. 1942. *Polarimetry, Saccharimetry and the Sugars*. Circular of the National Bureau of Standards C440, U.S. Department of Commerce, Government Printing Office, Washington, D.C.

for most, the use of a well air-conditioned room, especially in a warm or hot climate, is generally chosen for starters. (Caution: A small confined or closed space, with either numerous small or a few large-scale fermentations, should be ventilated with a good exhaust air system to remove CO₂ gas, as even at relatively low concentrations it is very toxic and can quickly lead to asphyxiation. Remember, CO₂ gas is colorless and odorless.) An alternative cooling method would be to add dry ice to the fermentation. One hundred pounds of dry ice will cool 100 gallons of fermenting must by about 20°F (13°C). Thus, if the temperature of the must begins to exceed 85°F (29°C), add about 20 pounds of crushed food-grade dry ice to each 20 or so gallons of must and thoroughly mix. (Wear heavy duty, padded, work gloves when handling dry ice.) Should food-grade dry ice not be available, substitute plastic gallon milk or water containers, filled with water and then frozen.

A more expensive alternative: Use a small stainless steel heat exchanger (copper or other metals are not recommended), either of plate design or coiled tubing, through which ice water or a refrigerant is pumped. The heat exchange unit is immersed into the must and coolant circulated through the unit while simultaneously the must is stirred around the cooling surfaces of the unit, either with a clean wooden stick or paddle or by using a motorized stirring unit or a slow, recirculating pump.

In summary, to achieve temperature control during fermentation on the skins:

1. Monitor fermentation progress by measuring and recording the °Brix of the juice at least twice daily.
2. Measure and record the temperature of the must several times daily.
3. Thoroughly break up the cap and mix with the juice by "punching down" two or more times daily.
4. Cool the fermentation as juice temperatures indicate.

When making temperature readings use a long-stemmed, probe-type thermometer so that it can be inserted readily through the must. Always measure the temperature of the must after punching down. Deviations from this procedure, such as removal of small samples of juice to measure temperature, can result in erroneous readings by as much as 10°F or more. Punching down the cap facilitates color extraction, aids in temperature control by allowing accumulated heat to dissipate, and is fun to do. It is easily accomplished, using a clean, wooden stick or post that has a small, clean paddle perpendicularly attached.

Those who wish to ferment on a larger scale, that is, 100 to 150 gallons or more, should use stainless steel tanks. Temperature control can be achieved by wrap-

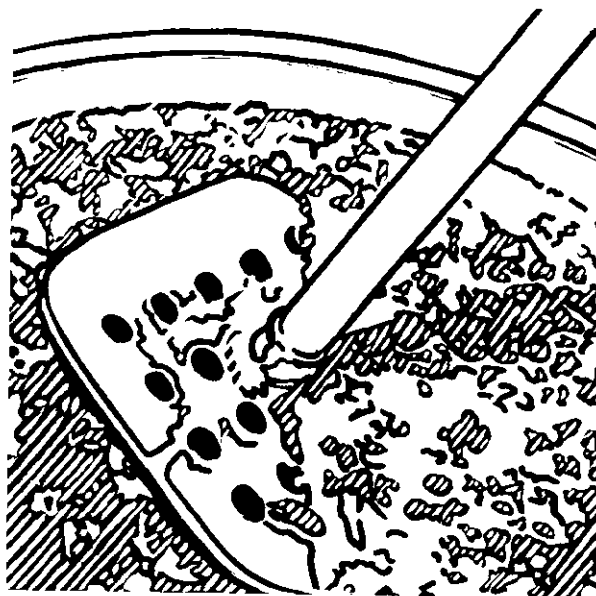

Punching down the cap

ping the outside of the tank with a special plastic cooling jacket called a heat exchange jacket. The jacket consists of very narrow, long, continuous coils of tubing through which can be pumped ice water or ice water containing brine or a refrigerant, such as propylene glycol. (Use of the latter requires a refrigeration system.) Such a plastic jacket can provide very good cooling, especially if insulated externally with about 1 inch of urethane foam. The heat exchange jacket is less expensive than a jacketed stainless steel tank, and if needed, can be easily removed and mounted on another tank. Plastic jackets are available from The Compleat Winemaker (see Sources of Equipment and Supplies for Home Wine Making).

If they can be found, 100- to 300-gallon, used, jacketed, stainless steel tanks from dairies serve well as temperature-control fermentors. In larger-scale fermentations, "pumping over" is used to break up the cap and mix the juice with the skins. This requires a valve opening located about 1 foot up from the tank bottom, to which a small pump can be attached. A hose is attached to the pump's discharge end and the juice is forcefully sprayed over the cap. Pumping over should be done at least twice daily and perhaps more often, depending upon fermentation temperature, must volume, and grape variety. Each time pumping over occurs, all of the juice should be pumped over the cap solids. Appropriate types and sizes of pumps, hoses, fittings, and valves are available from many home wine supply shops.

When not punching down or conducting measurements, keep the open-top red wine fermentors covered

with a double layer of cheesecloth or plastic sheet. This not only keeps out insects but traps evolving CO₂ vapors, which inhibit growth of spoilage bacteria. As fermentation proceeds, the °Brix will steadily decrease. For most varieties, once the Brix has dropped to about 6° to 8°, about 90 percent of the color will have been extracted during the first 3 to 5 days of fermentation. Longer fermentation on the skins will extract more tannins; the result is that the wine may require more aging before it becomes palatable. Conversely, early pressing off the skins will result in a fresh and fruity wine that can be consumed while relatively young, but with less color and limited aging potential. This presents a choice for the winemaker. We suggest that if sufficient grapes and other supplies are available, the beginner may want to try one lot pressed at 10° to 12° Brix, a second lot at about 5° Brix, and a third lot at dryness (-2° Brix or less). After tasting each lot, let your taste determine when you prefer to separate the juice from the skins in subsequent wine making. Keep in mind, however, that subsequent lots of grapes may not have the same composition and color content.

As mentioned, should a fermentation “stick” or cease before completion it is difficult to restart. This problem usually occurs due to too high fermentation temperatures or to insufficient yeast nutrients. Whatever the cause, the following actions are recommended:

1. Cool or warm the must, as appropriate, to about 68°F (20°C).
2. Add a fresh, actively growing yeast starter.
3. Add a yeast nutrient, such as Yeastex.

At the time of yeast re-inoculation, aerate the must by stirring or pumping over two to three times daily for 1 to 2 days. Fermentation should resume. If after several days, fermentation has not started, try a second re-inoculation. While waiting for fermentation to restart, keep the must or wine at the proper temperature. Whenever possible, use must or wine from an active fermentation for the yeast inoculum. Failure to restart after several attempts only emphasizes prevention; do not add excessive sulfur dioxide and maintain proper fermentation temperatures.

Pressing

This operation can be accomplished with a basket press or by squeezing batches of must through several layers of washed cheesecloth. (Wear rubber gloves to avoid staining the hands.) The squeezing is lengthy, requires considerable physical exertion, and results in poor yields. Using a basket press is recommended for the serious winemaker, working with one-half ton or more of grapes (fig. 3). Basket presses are available in

various sizes, either hand-operated, motor driven, or hydraulic driven. The basket press, probably the most expensive piece of equipment needed in home wine making, is also one of the most worthwhile investments. A properly cared for press should provide a lifetime of trouble-free service.

Fill the basket with partially fermented must and allow the liquid portion to flow freely into a stainless steel bucket or a polyethylene plastic pail covered with plastic window screen to catch solids. Discard solids (pomace) from the screen surface as needed. This portion of the partially fermented juice or wine is referred to as the “free-run,” and after all of it has been collected, apply pressure slowly and not for too long a time. Too rapid application of pressure causes the wet solids to squirt through the basket openings, which defeats the pressing operation, results in losses, and creates a mess throughout the work area. Some or all of the press wine may be added to the free-run or all of it may be kept separate; press wine can yield an additional 20 to 40 gallons. The more press wine added to free-run, the higher the tannin content; hence, a more astringent wine that will require more aging. Some winemakers prefer to keep the press wine separate and use some of it later for topping during aging.

As pressing proceeds, the free-run and/or the press wine should be placed into narrow-necked glass containers or clean oak barrels to about 90 percent of capacity, for fermentation to complete. (If you have chosen to ferment to dryness on the skins, proceed to the

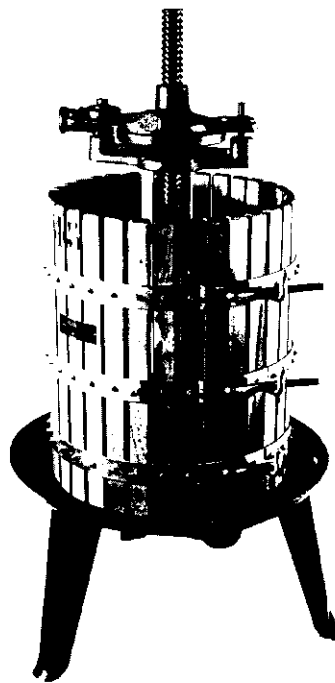

Fig. 3. Basket press

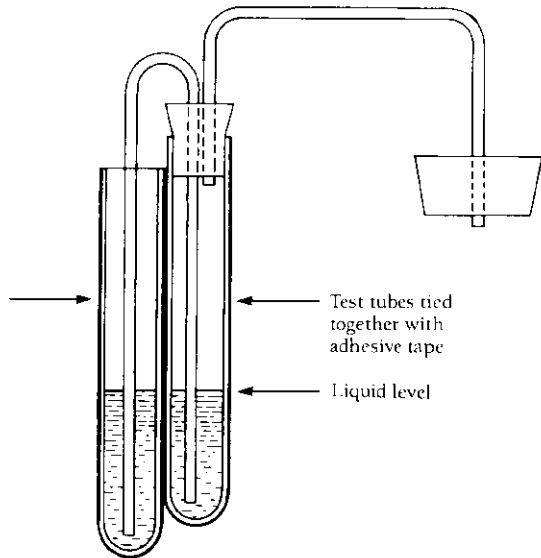

Fig. 4. Diagram of fermentation trap

discussion of malolactic fermentation.) These fermentors should be equipped with a fermentation trap (fig. 4) to protect the wine from air contact and oxidation. The trap allows carbon dioxide to escape, prevents air from entering, and should be kept in place until the wine is ready for its first racking. Before continuing with this and subsequent steps in wine making, read the discussion below on malolactic fermentation. It is discussed now because of its importance in making red wine.

Malolactic fermentation

A phenomenon distinct from alcoholic fermentation, this fermentation is accomplished by the activity of lactic acid bacteria, most commonly by species of the genus *Leuconostoc*. The term malolactic refers to the ability of these bacteria to convert malic acid to lactic acid and carbon dioxide, usually during or soon after alcoholic fermentation. Malic acid, one of the organic acids naturally present in grapes, is a stronger acid than lactic acid. Thus, the most marked change brought about by these bacteria is reduced acidity. In warmer grape growing regions, this deacidification is not desirable and is discouraged; in the cooler regions it is encouraged.

Malolactic fermentation is widespread among wine districts worldwide and is common in certain California red wines. Often the winemaker will encourage it by inoculating the fermenting must with a pure culture of the bacteria. Once malolactic fermentation is completed, the wine can be considered stable and can then be bottled and aged. Wines that have not undergone this fermentation before bottling are unstable; if fermentation occurs after bottling, the carbon dioxide gas pro-

duced can cause corks to push out with resulting wine loss, oxidation, and spoilage. Generally, better quality California red table wines have undergone malolactic fermentation, perhaps in part because the metabolism of the bacteria during the fermentation improves flavor complexity. When using California grapes, except those from the warmest growing areas, we recommend the malolactic fermentation in red table wines but do not recommend it for white table wines. Malolactic fermentation may be desirable in white table wine, if the grapes were grown in a very cool area, where acidity is naturally high (10 g/L or higher). In cases where the malolactic fermentation causes too much loss of acidity, this can be remedied by adding tartaric acid.

Several factors can either encourage or inhibit a malolactic fermentation. Malolactic bacteria have complex nutritional requirements for growth. These nutrients are either naturally present in wine or released into the wine by yeast cells during alcoholic fermentation. Thus, bacterial growth is enhanced the longer the wine is left in contact with the lees or inhibited if the wine is separated from the lees soon after alcoholic fermentation. Other factors that will tend to inhibit bacterial growth include: Low pH (3.3 or lower); relatively high levels of SO_2 (adjusted to at least 100 ppm after yeast fermentation); cool storage temperatures, 60°F (15.6°C) or lower; and nonuse of wooden cooperage. Conversely, wines more apt to undergo the malolactic fermentation have a higher pH (3.4 and above); have low levels of SO_2 (not above about 50 ppm total after alcoholic fermentation); are stored at warm temperatures, 65° to 86°F (18.3° to 30°C); and are held in wooden cooperage with a history of this fermentation. Unfortunately, relatively low SO_2 and warm storage conditions also favor development of spoilage yeasts and vinegar bacteria and wines held for too long under these conditions are indeed at risk. Therefore, practice careful sanitation.

As mentioned, the inoculation of partially fermented must with a pure malolactic culture, under favorable conditions, will usually induce a malolactic fermentation. A few firms sell starter cultures, which should be purchased 2 months before intended use. The major reason for discussing this subject at this point is that experience indicates that probably the best time to inoculate is at the beginning or sometimes at about the middle of the alcoholic fermentation, e.g., at pressing. Even with apparently favorable conditions, including inoculation of the must or wine, malolactic fermentation sometimes will not occur. If it does not occur several weeks after alcoholic fermentation has ended, even when it has been encouraged and the winemaker is anxious to bottle the wine, the total SO_2 should be increased to at least 100 ppm (30 ppm free SO_2), the temperature lowered, and the wine clarified by racking or filtration, and then bottled.

An easy and reliable method for determining whether a wine has undergone malolactic fermentation is by the paper chromatographic separation and identification of malic and lactic acids in the wine. This simple test requires no special skills or training and provides decisive results (see Chapter 7).

Completing alcoholic fermentation

The following discussion does not apply if fermentation on the skins has been allowed to proceed to dryness. Monitor the progress of this final phase of the alcoholic fermentation with daily hydrometer readings and temperature checks. Up to 2 weeks may be required to ferment the remaining sugar, depending upon temperature and other factors. Fermentation temperature should be maintained at between 65° to 75°F (18.3° to 23.9°C); during this phase, the fermentation rate is slower and less heat is generated. The fermentation can be considered complete (when the wine is dry); that is, the wine contains less than 0.2 percent reducing sugar, as determined by the reducing sugar tablet test (see Chapter 7). After fermentation has finished, keep the wine in its secondary fermentor with fermentation trap in place. During the next 2 to 3 weeks, spent yeast cells and other particulate matter will settle to the bottom of the fermentor, forming a sediment referred to as fermentation lees. If the malolactic fermentation has also been completed, proceed with racking (see next section). If it has not been completed, and completion is desired, leave the wine on the lees a while longer (perhaps 1 to 3 weeks) and follow the suggestions and precautions indicated previously. If it is not desired, the wine should be racked, the SO₂ adjusted, and the wine aged or bottled.

Racking

Racking or siphoning, a simple and convenient technique for clarifying wine, should be done carefully, so that the wine will obtain a degree of clarity satisfactory to most winemakers as well as to wine consumers. By siphoning or racking, clear wine can be separated from sediment in one container and transferred to another clean container. For small-scale operations, utilize clean, food-grade rubber or plastic hose of about 1/2 inch inside diameter and 4 to 6 feet long (see Chapter 8 regarding materials used in wine processing). For larger volumes—100 gallons or more—larger diameter and longer hoses and pumps may be used. Insert one end of the hose into the wine several inches below the surface, apply suction to the outlet end, and immediately insert it into the receiving container toward the bottom to avoid aeration. The outlet end of the hose must be below the inlet end, but the difference should not be too great to avoid disturbing the sediment (fig. 5). Very carefully lower

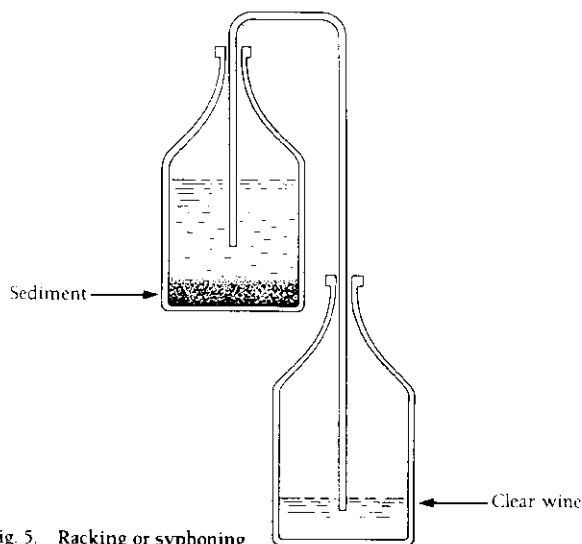

Fig. 5. Racking or syphoning

the inlet end of the hose gradually into the wine being transferred as the sediment is approached. Don't try to transfer every last bit of clear wine from the sediment, as once the sediment is disturbed, it quickly transfers to the receiving container. When racking wine from one barrel into another, notice that liquid levels and sediment layers cannot be seen. Therefore, attach a clean stick to the inlet end of the hose so that the stick extends about 4 to 6 inches beyond the hose opening (fig. 6). The stick with attached hose should be lowered very slowly through the sediment to the barrel bottom. This technique will prevent the inlet end of the hose from entering into the layer of sediment, unseen from the

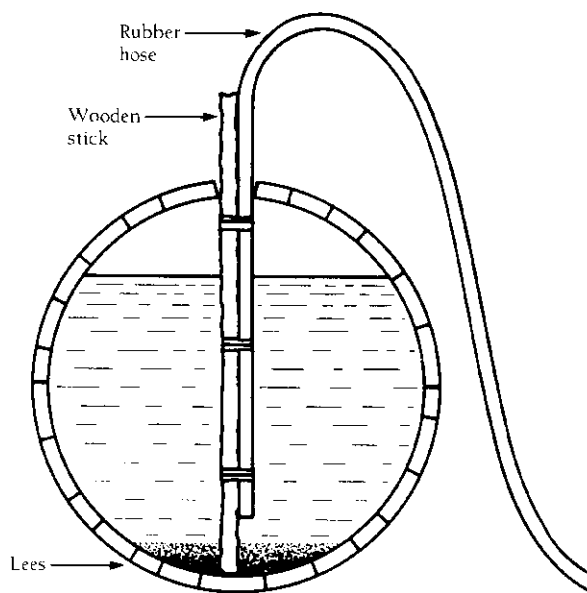

Fig. 6. Racking hose affixed to stick for barrel racking

barrel's exterior. Some home wine shops sell racking hoses especially designed for barrel racking. The first racking off the fermentation lees results in the greatest loss of volume. In subsequent rackings, the hose may be lowered closer to the bottom of the barrel, since there is a smaller amount of lees.

New wine racked off the gross fermentation lees is usually transferred into a clean oak barrel for aging. It may also be transferred into a clean glass carboy, jug, or other suitable container. Because the SO₂ initially added is exhausted during fermentation, it should be added again at this time (about 50 to 75 ppm, but not over 50 ppm total SO₂, if the malolactic fermentation has not yet occurred and is desired). The barrel should be completely filled and the bung loosely inserted into the bung hole for the next 2 weeks or until malolactic fermentation ends. After that, the barrel should be filled to the point of almost overflowing and the bung inserted tightly. Usually, additional rackings every 4 to 6 weeks up to a total of four or five rackings will facilitate clarification.

Aging and topping

Most red wines benefit from aging in oak barrels. In addition to the many slow reactions that occur during aging, wood extractives contribute to the wine's overall flavor complexity. Naturally, care should be taken to avoid excessive woodiness by controlling the wood aging time. New barrels will impart more wood flavor much faster than will older, used barrels. Thus, special care should be exercised when aging wine in new barrels and especially in barrels smaller than 50 gallons capacity. Whereas, red wines are generally aged in used 50- to 60-gallon barrels from 1 to 2 years or more, they would be aged only 1 to 3 months or less in new barrels of the same size. Wine in new oak barrels should be tasted every 1 to 2 weeks and, once it has attained the desired degree of oak character, as determined by taste, it should be transferred to a "neutral" or older, used barrel for further aging or storage if desired. If no further aging seems necessary, it should be transferred to glass storage containers or bottled.

During aging in old used barrels for the first year, the wine should be racked about every 2 to 3 months for a total of three to five rackings. These rackings are in addition to the initial racking from the fermentation lees. Wine can also be stored and aged in glass containers, but, of course, it will not obtain wood flavors. The containers must be filled completely, tightly sealed with tapered corks, and stored on their sides to keep the inner surface of the corks moist with wine. With 1-gallon jugs or larger glass carboys, the cork must be tied to the neck of the container to keep it in place, because pressure builds up from temperature changes or from gas formation or dissolution.

Topping is the winemaker's most important task during barrel aging. As wine ages, some is lost by evaporation or ullage, typically a 2 to 5 percent volume (1 to 2 gallons per 50-gallon barrel) loss per year. The ullage rate is directly related to temperature, relative humidity, and the size of the barrel, or the ratio of surface to volume. The ullage rate is more rapid in small barrels (larger surface-to-volume ratio) stored under warm conditions. Wine lost to ullage must be replaced to avoid oxidation and to prevent growth of vinegar bacteria, which will develop in the presence of air under favorable temperatures. Thus, wine should be aged under cool conditions, not above 60° F (15.6°C) and preferably 52° to 55° F (11.1° to 12.8°C). The barrels should be topped with wine as needed, at least every 2 weeks, and the SO₂ checked and adjusted after each racking to maintain a level of about 20 to 25 ppm free SO₂. Topping wine should be kept in completely filled glass containers and its SO₂ kept at the same level as the wine being topped. If all the wine in a gallon jug is not used for a single topping, the remainder should be placed in smaller glass bottles that are also filled completely and tightly corked for use in the next topping. Screw-capped bottles are convenient small containers for topping wines and must be clean; the inner seal should be plastic or coated paper, also clean, and in sound condition. Do not use rusty or corroded caps. Topping wine can be wine you have produced or purchased, but it should be the appropriate color and a similar type. Be sure to taste the topping wine for off-odors or off-flavors before use, as it can cause contamination.

Aging will vary according to the grape variety used, the size and age of the barrel, and the desired level of wood flavor. Due to the greater surface-to-volume ratio, wine aged in 5- or 10-gallon used barrels will mature relatively quickly, within a month or so. Wines in used 50- or 60-gallon barrels usually will require 1 to 2 or more years before they are ready to finish and bottle. Note previous comments about new barrels.

Before use, barrels should be washed and thoroughly rinsed and should be clean smelling. Barrels that leak or that have been allowed to sour through lack of proper care should not be used. (Cleaning, sanitizing, and care of cooperage are discussed in Chapter 8.)

To attain wood character, a rapid, convenient, and generally satisfactory alternative to barrel aging is the use of oak chips or granular oak. These materials can provide wood odor and flavor in wine stored in glass or stainless steel containers and can enhance the oakiness of wine aged in very old barrels. The amount of chips or granules required to produce a recognizable taste effect is relatively small and is determined by individual preference. Simply add a small amount; usually from 100 to 300 grams per 50 gallons of wine (3.5 to 10.5 ounces per 50 gallons) are sufficient. Allow to stand for up to 1

week with occasional gentle mixing. Compare the taste with untreated wine. Once the desired wood flavor has been obtained, the oak chips or granules are separated from the wine by rough filtration. Or to avoid filtration, the oak materials can be contained in a cheesecloth bag that is then suspended in the wine. Another method: The wine is allowed to trickle slowly through a cylindrical column packed with the chips or granules. Some winemakers prefer using alcoholic oak extract that may be purchased ready to use or prepared at home.

A suggested recipe for oak extract follows: Add 4 oz of oak chips (previously rinsed in cold water and drained) to a half-and-half mixture of vodka and white wine. Warm to about 100°F. Allow mixture to stand for 2 to 3 months. Small amounts of this extract will impart considerable oak flavor.

Because oak chips or granules are made from either American or European oak, different sensory effects can be produced according to preference. Home winemakers are encouraged to try these various oak treatments for introducing flavor complexity easily and quickly and improving wine quality. Contact your home wine shop for availability.

Bottling

The wine is “ready” for bottling after the desired degree of wood aging has been attained, as determined by taste, and malolactic fermentation has been completed. It should also be assessed as free of apparent or preventable defects or instability(s) within quality standards acceptable to each winemaker, by examination for desired clarity, smell, and taste. If any off-odors or off-tastes or other defects are detected, refer to Chapter 5 (on spoilage and stability problems) before proceeding with bottling. Finally check the free and total SO₂. It is customary to adjust the free SO₂ as needed to about 25 to 30 ppm (100 to 150 ppm total) at bottling. This helps to prevent oxidation of the wine after bottling due to dissolved oxygen already present in the wine or oxygen that may be picked up during bottling. Bottling equipment, bottles, corking devices, and corks are available from home wine making shops.

When selecting bottling devices, it is highly desirable to minimize aeration, which in turn will minimize oxidation of the wine after bottling. This is best achieved using devices that provide for gravity flow of the wine and fill the bottles from the bottom. Such bottling devices are often referred to as “gravity bottom filling.” New wine bottles should be rinsed in hot water to remove dust particles and air dried before use.

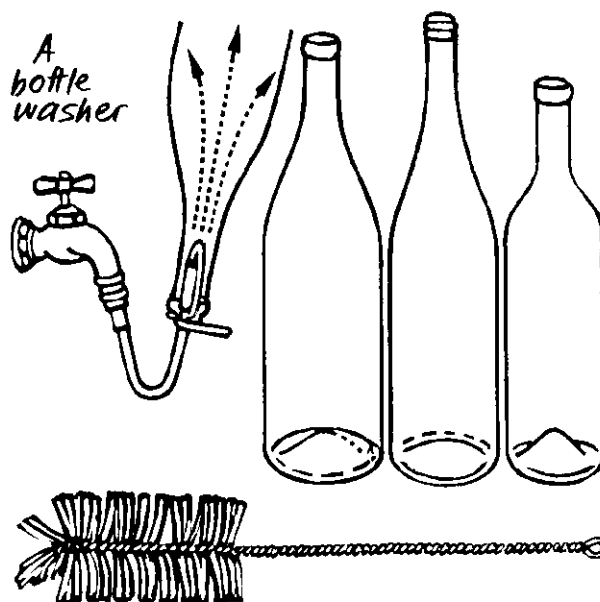

Used wine bottles should be washed with hot water and detergent solution using a bottle brush, thoroughly rinsed, and air dried before filling. Fill each bottle to allow only about a ¼-inch space between the wine level and the inserted cork in the neck of the bottle. This will minimize air contact with the bottled wine and avoid development of oxidized flavors. Corked bottles of wine should be labeled with appropriate identification information and dates and stored on their sides to keep the inner surface of the cork moist for a tight seal. Most red wines will improve with some bottle aging, while many achieve optimum complexity and palatability after 1 to 3 years or more.

Making rosé or pink table wines

As in red table wine making, these wines are usually made from red grapes that are crushed and stemmed. The juice is allowed to stand in contact with the skins for only 8 to 12 hours, and pressing is done when the desired pink color has been obtained. After pressing, fermentation and all other steps are as described for making white table wine, including juice settling, fermentation, and storage at the recommended cool temperatures. As with white wine, wood aging is not usually preferred and the wines are bottled as soon as possible for early consumption.

Alternatively, rosé or pink wines can be made by blending white and red wines. Stabilization and finishing are performed on the blend.

4

Making White Table Wines

Figure 7 is a schematic presentation of the steps involved in making white table wines. As in red wine making, each step is discussed in detail. In making white wines *do not use as fermentors, barrels that have been used for red wine making*, as the red pigments will leach into the white wine. Plastic or stainless steel equipment, that has been thoroughly washed with hot water detergent solutions to remove red pigments after each use, can be used interchangeably for white and red wines.

Crushing, stemming, and pressing

In contrast to red wine making, crushing, stemming, and pressing are discussed as one operation to emphasize the importance of separating the juice from the skins, seeds, and pulp (pomace) as early and as quickly as possible. This is done so that only minimal amounts of tannins or bitter substances are extracted from the pomace into the juice. Crushing and stemming is accomplished as in red wines. The must is then pressed

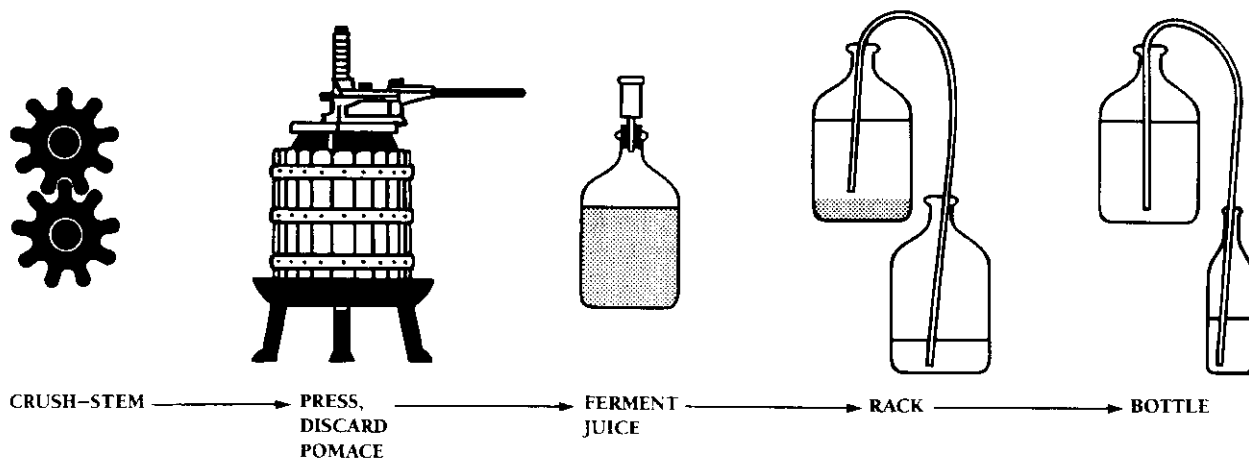
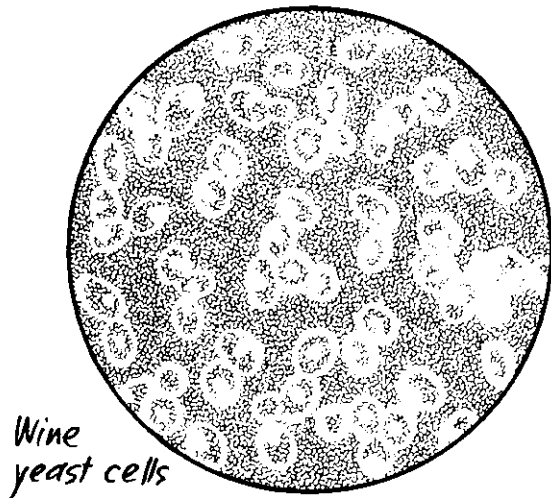
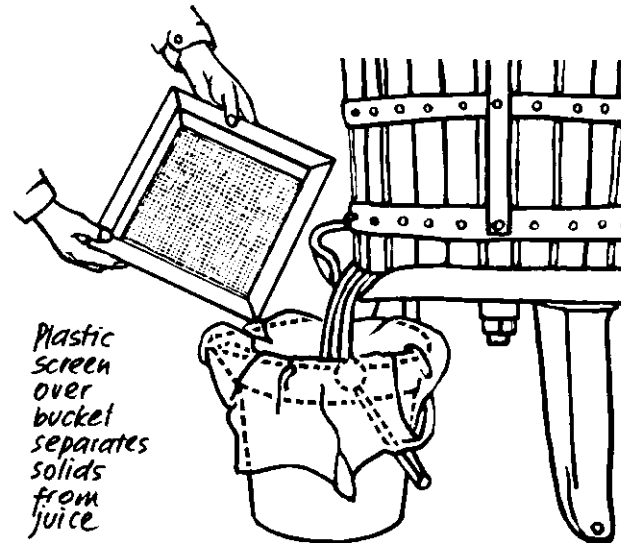

Fig. 7 Essential steps in white wine making



Wine yeast cells



Plastic screen over bucket separates solids from juice

immediately to obtain the juice for fermentation. Pressing juice from freshly crushed white grapes is not as easy as pressing in red wine making, where fermentation has rendered the skins less slippery. If pressing in a basket press, allow all of the free-run juice to drain from the basket without pressure. Apply pressure gradually, using not too much for prolonged periods. With some varieties it may be necessary, as pressure is applied, to place some stems around the slats near the top in the basket to help keep the juice and skins from squirting sideways through the slot openings. Clean rice hulls or any other inert press-aid added to the must, as the basket is filled, may also facilitate pressing.

There are two possible exceptions to pressing immediately in white wine making. The first is related to flavor enhancement. Some commercial producers of Chardonnay and Sauvignon blanc believe that the wines of these varieties obtain increased varietal aroma and flavor with some juice and skin contact time. Thus, after crushing and stemming, but before pressing, the juice is allowed to remain in contact with the skins from 2 to 8 hours at 50° to 55°F (10° to 12.8°C). Skin contact should only be practiced if the must can be kept cool, as at higher temperatures than indicated more bitter and possibly other undesirable phenolic components are extracted. In addition, skin contact should not be used with overripe, moldy, or rotten grapes. Excessive skin contact can lead to cloudiness or haze formation in the wine at some later stage. Also, note precautions about adding SO₂.

A second possible exception to immediate pressing is a supplement to pressing, variously referred to as the "crush/drain tank method" of juice separation or "crush and drain." This method allows for separation of the free-run juice from suspended solids (skins, seeds, and

pulp) by natural means, but it does not replace pressing. With draining, the must in a "crush tank" or "drain tank" is allowed to stand for several hours while the skins float to the surface of the juice and form a cap, similar to the cap formation in red wine making. As soon as possible, usually after about 8 hours, draining of the free-run juice is commenced from near the bottom of the tank. The free-run juice is thus collected and separated from the pomace, after which the pomace is transferred to a press for further juice extraction. This method of juice separation is convenient for very large operations that involve large volumes of juice; it is not recommended for small operations, since the prolonged time required for cap formation greatly increases the risk of browning and oxidation, even when SO₂ has been added. Perhaps it could be considered in conjunction with skin contact when desired, if time and temperature are carefully controlled. A third juice separation method is the use of "Potter" drainers or similarly designed draining tanks. These specially designed tanks are internally fitted with sieve-screens that not only separate skins and seeds, but also substantially reduce suspended solids. The free-run juice, so drained, can be fermented without clarification, and draining can be started about 1 hour after filling the drainer.

Due to the high susceptibility for browning or oxidation in white wine making, it is important to provide reducing conditions for the juice as soon as practicable, as when alcoholic fermentation commences.

As in red wine making, collect the free-run and light-press juice in a plastic or stainless steel bucket covered with a plastic window screen to catch skins and grape particles. The free-run and press-juice can be kept separate or combined. The juice is then transferred to narrow-necked glass fermentors that are then fitted with

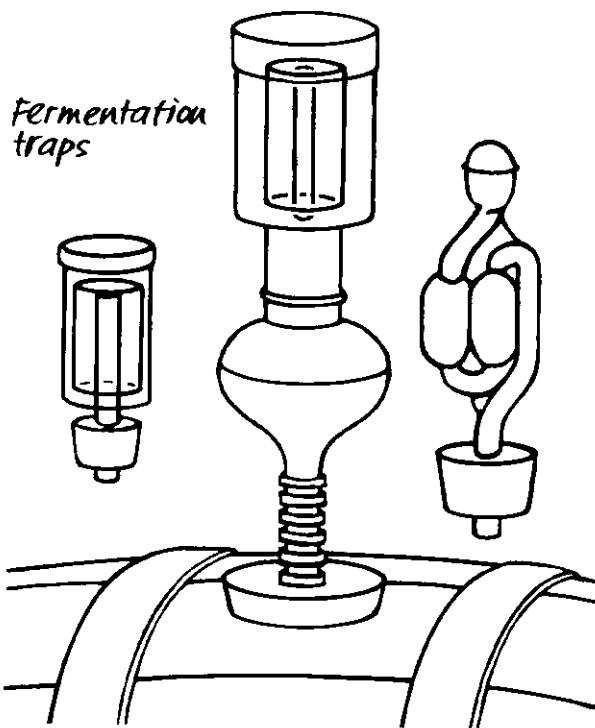

a fermentation trap (fig. 4). Clean barrels may also be used and of course must also be fitted with a fermentation trap. The fermentors are filled to about two-thirds capacity.

Because of the physical characteristics of unfermented crushed white grapes, juice separation (pressing) from the pomace is difficult. Thus, juice and wine yields will be less than that obtained in red wines. In home wine making, usually only about 100 gallons per ton can be expected with white grapes, with some varieties yielding less and others slightly more.

Note that white wines, such as the so-called “Blanc de Noir,” “White Zinfandel,” or “White Gamay,” can be made from red grapes if they are pressed immediately after crushing and stemming. Such wines will have a slight orange or pink hue, but if processed as in white wine making, palatable wines can be made, although they cannot be expected to possess much varietal aroma and flavor.

Adding sulfur dioxide, settling, adding yeast, and fermentation

Generally, these steps are the same as in red wine making, but there are important differences. White wine making is inherently more difficult than red wine making because, as mentioned, the juice used in making white wines, as well as the wines themselves, are more

susceptible to oxidation and browning. Browning is a change in the usual light straw yellow or light greenish yellow color appropriate to white wines, to a dark yellow, amber, or brownish color—similar in appearance to some sherries. Browning-oxidation reactions occur in the presence of air and are accelerated under warm to hot temperatures. They are retarded under cool conditions in the absence of air. These undesirable color changes are prevented by promptly adding sulfur dioxide to the must and thoroughly mixing. With grapes that are sound and free of mold or rot, use about $\frac{1}{3}$ ounce, or $\frac{1}{4}$ teaspoon, $K_2S_2O_5$ (equals about 100 ppm SO_2 for each 10 gallons of juice) or the appropriate amount of 10 percent $K_2S_2O_5$ solution. If the grapes show signs of mold or rot or have broken skins, double these amounts of SO_2 .

Another important difference from red wines is that in white wine making the best quality is obtained by fermenting clarified juice. Not only is the aroma enhanced by fermenting the clarified juice, but if the grapes had been dusted with sulfur shortly before harvest (used in powdery mildew control), elemental sulfur present in the juice will settle out. Juices fermented when elemental sulfur is present commonly result in wines containing hydrogen sulfide, a most unpleasant and undesirable off-odor. Therefore, keep the juice cool (preferably not above 60°F) and allow to stand overnight, so that suspended material will fall to the bottom. The clear juice is then racked from the lees. Do not take any of the not-so-clear juice near the bottom, even though 10 percent or so of the initial volume may be lost. Large quantities of juice (200 gallons or more) may take 24 hours or longer to settle, but the resulting quality is worth the wait.

Follow the instructions, as in red wine making, for adding pure wine yeast starter cultures. Other instructions regarding measurements of temperature, °Brix, titratable acidity, pH, and free and total SO_2 also apply. Fermentation of white wines should be conducted at a temperature cooler than that employed for red wines, a constant temperature not above 60°F (15.6°C), with 55°F (12.8°C) ideal. At these cooler temperatures, the fermentation will require from 2 to 3 weeks to reach dryness with a decrease in Brix of about 1° to 2° per day. Temperature control is achieved as suggested in red wine making. Again, more heat is generated during the stage of vigorous fermentation activity. Monitor the decrease in °Brix and the temperature at least twice daily or more often as indicated by the evolution of CO_2 gas bubbles in the fermentation trap.

Once fermentation has been completed, leave the fermentation trap in place and allow the spent yeast cells and other suspended matter to settle to the bottom of the fermentor, again keeping the wine between 55° to

60° F. After 1 or 2 weeks, the new wine should be racked from the fermentation lees into another clean container (preferably glass), and the free SO_2 adjusted to about 50 ppm. The container should be filled completely with wine and fitted with a fermentation trap or loosely stoppered to allow any residual CO_2 to escape and to prevent air from entering.

Racking, topping, aging, and bottling

The new wine should be kept at about 60° F (15.6° C) or lower. To facilitate further clarification, the wine should be carefully racked at 3- to 6-week intervals; usually three to five more rackings are needed. Keep the storage container completely filled by topping and tightly stoppered to prevent oxidation. Alternatively, a fermentation trap can be used until rackings have been completed. It is wise to check the free SO_2 level after each racking and to adjust as needed to about 25 to 30 ppm free SO_2 .

As indicated previously, most white wines are not aged in wood or aged for prolonged periods since, with most varieties, the objective is to preserve as much as possible the grape's fresh and fruity aromas and flavors. One notable exception, the variety Chardonnay, many agree, does obtain complexity from brief oak aging. Another possible exception: Sauvignon blanc. This

should be done according to taste preference. Again, if oak flavor is desired, consider using oak chips, granules, or extract. Certain white wines may develop a cloudiness (an opaque or "milky" haze) after treatment with granular oak or oak chips. This is most likely caused by a tannin (from the wood) and protein (present in the wine) combining to form an insoluble complex; the wine should clarify upon standing after several days to a week or so. To remove this material, the wine is carefully racked, or filtered. Such cloudiness more often develops in white wines that have been treated with European oak chips or granules and will expose or identify those wines that contain an excess of unstable protein.

If careful rackings have been practiced, the wine should be clear enough for bottling after about 3 to 6 months and ready for consumption then or after a year or more of bottle aging. Bottling procedures and bottle aging are the same as described for red wines, except that white wines should be bottled with a free SO_2 content of about 35 ppm. Screw-cap bottles may be used, if the caps have plastic inserts or liners; bottles with such closures do not need to be stored on their sides, but should not be stored for prolonged periods. Ideal wine storage temperature is 52° to 60° F (11.1° to 15.6° C).

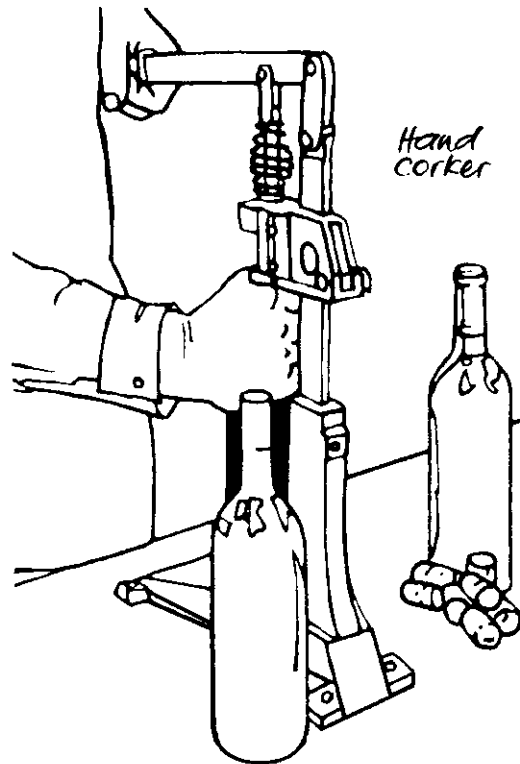
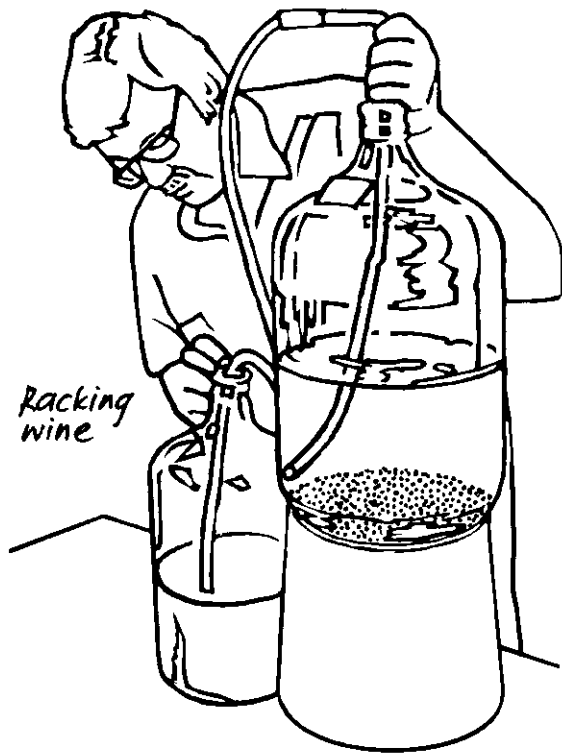

5

Potential Spoilage and Stability Problems

Certain problems can arise even when the wine-maker follows recommended methods. Some are best handled by preventative measures; others are generally not considered important in wines made at home for family consumption, but may be important to those interested in wine judgments or simply as a matter of pride or achievement. The major potential problems, their prevention or remedy, are dealt with next.

Acetification and oxidation

In acetification acetic acid bacteria present in wine under favorable (to the bacteria) conditions will slowly convert alcohol to acetic acid and ethyl acetate, the main components of wine vinegar. This undesirable change is readily prevented by following recommended wine making practices. Specifically, judiciously use sulfur dioxide, avoid air contact with the wine, and keep the wine at 60°F (15.6°C) or below. When these measures are not

followed, bacteria can become established and acetification will start. *The reaction, once under way, is irreversible!* Even worse, should this occur in wine stored in an oak barrel or cask, these containers cannot be used again for wine making because there is no known way to sterilize the wood effectively.

Simple oxidation results from excessive or prolonged exposure of wine to air when insufficient or no SO₂ is present. Development of a brownish color and oxidized odors and flavors is readily apparent, especially in white wines not protected from exposure to air.

Hydrogen sulfide (H₂S)

The distinctive "rotten egg" odor of this obnoxious compound can be detected by smell at very low concentrations, that is, 1 ppm or even less. Its formation and presence in wine most often arises from the reduction of elemental sulfur (residue of sulfur dust on grapes from powdery mildew control) by the yeast, and can



occur even when the very best wine making practices are followed. As soon as the presence of H_2S is noticed, every effort should be made to remove it. Hydrogen sulfide is often formed during alcoholic fermentation, especially near the end of it, or some time after alcoholic fermentation when the new wine is still in contact with the yeast. When it is detected, it is sometimes possible to convert the H_2S back to sulfur by adding sulfur dioxide or by vigorous aeration to volatilize it from the wine. (Note: This is the only circumstance when deliberate aeration of wine is recommended.)

For small wine lots, pour the affected wine from its container, with splashing against the sides of another container, such as a clean plastic bucket, tub, or other suitable container. For larger volumes, pump the wine from one container to another, with the discharge end of the hose directed toward the wall of the receiving container to achieve splashing. This transfer with splashing may have to be repeated several times.

Well separated from the working area, smell the wine in a tasting glass after aeration or SO_2 addition. If it appears to be free of H_2S , filter the wine, and again adjust the free SO_2 from 30 to 50 ppm (lower amounts for red wine, higher for whites). Next, place the wine in a suitable storage container, following the instructions given for racking, topping, and aging. After a week or so, smell another sample. If H_2S is still present, repeat SO_2 addition or aeration, and filtration, followed by final SO_2 adjustment. This problem can be solved if detected early and the wine treated immediately. Filtration following SO_2 addition or aeration is required to remove elemental sulfur, which can be seen as a haze in the wine. If the sulfur is not removed, it can be reduced again to form H_2S .

As mentioned in white wine making, if the juice is clarified before fermentation, the possibility for H_2S to form from elemental sulfur is greatly minimized. During settling, suspended solids including elemental sulfur, settle out. Of course, this technique for preventing H_2S from forming is not feasible in red wine making, as the juice must be fermented on the skins for color extraction. And discouraging as it may be, it must be said that adding SO_2 or aeration will not always remove H_2S . Furthermore, H_2S may be formed even when elemental sulfur is not present. Deficiency of certain amino acids during fermentation may cause the yeast to form and accumulate H_2S . Adding diammonium phosphate at the time of yeast inoculation (1 to 2 oz/100 gal) should minimize the potential for this to occur.

Other very undesirable sulfur-containing compounds, such as mercaptans, can be formed if H_2S is not removed early. The odor of these compounds has been described as garlic or skunky, and it is very difficult to remove, without adding certain chemicals that themselves may cause other instabilities.

Cloudiness and deposits

Under certain conditions, several naturally occurring substances in wine can lead to development of a cloudy or hazy appearance or crystalline deposits. These are usually of no concern to the home winemaker, but they are important to the commercial winemaker who must satisfy consumer demands for brilliantly clear wine free of deposits.

A common cause of cloudy appearance is an excess of certain proteins in the wine that may, under prolonged warm storage conditions, 70° to 85° F (21.1° to 29.4°C) or higher, form complex substances that remain in suspension and appear as a haze. This cloudy appearance is readily apparent in a white or pink wine. If this kind of instability is unacceptable to the home winemaker, the wine can be protein (heat) stabilized by treating it with an inert clay, bentonite, which removes some protein. (This treatment is called bentonite fining.) The wine can be bentonite fined anytime after the first racking and before bottling, but we recommend before barrel aging. Usually adding about ½ ounce to 1 ounce bentonite for each 10 gallons of wine is sufficient for most white varieties. Others, such as Riesling, Muscat, and Sauvignon blanc, may require twice this amount for complete stability.

Bentonite comes in the form of clay granules, and is available from home wine making shops. For maximum effectiveness, it should be rehydrated before use in a 6 percent solution of hot water, thoroughly mixed to avoid clumping of the clay, and finally allowed to stand 24 hours. After fining, the bentonite is allowed to settle and the wine racked from the bentonite lees, or the wine may be filtered to remove it.

Very small, often needlelike crystals of potassium bitartrate (KHT) are the most common precipitate or deposit encountered in wine stored for several days or longer under very cool conditions, 40° F (4.4°C) and lower. Tartaric acid is the predominant organic acid in most *vinifera* grape varieties and readily forms the salt potassium bitartrate. Wine can hold only a certain amount of KHT in solution, the solubility of which depends upon several factors, including temperature. As the wine's temperature is reduced to the usual refrigerator temperature of about 37° F (2.8°C) or lower, KHT crystals start to form and will eventually precipitate from solution to form a deposit. Knowledgeable wine consumers accept this phenomenon as natural to wine. Also, when the wine is warmed to room temperature 68° to 70° F (20° to 21.1°C), most, if not all, of the crystals usually return to solution. Thus, KHT stabilization is not required, but can be achieved if desired. The most common method for reducing excess KHT is to chill the wine to 23° to 25° F (-5° to -3.9°C) and to hold it at that temperature for 2 to 3 weeks. This causes

the excess KHT to crystallize and then precipitate. The wine must then be racked carefully or filtered at the same low temperature. The process is facilitated by adding powdered KHT, which acts as a "seed" for crystallization, and is thoroughly mixed with the wine throughout chilling. Cold or potassium bitartrate stability might be accomplished without refrigeration by using a proprietary compound such as Koldone. The manufacturer of this material suggests that 1 ounce for every 10 gallons of wine will achieve KHT stability, and depending upon the wine being treated, it will also reduce titratable acidity by about 1 gram per liter. If the wine is already low in acidity, this can be an important consideration. Note also, if the wine pH is high, using this agent could lead to calcium bitartrate instability. Therefore, although this material may work in certain wines, it can also create other problems.

When wines are barrel aged for extended periods under cool conditions, excess potassium bitartrate precipitates out and forms crystalline deposits on the inside of the barrel. Naturally, as this deposit accumulates, it reduces the wine's exposure to the wood surface; this in turn limits the extraction of desirable wood components by the wine. Moreover, because the KHT deposit is a rich medium for the growth and development of various spoilage organisms, it should be removed each time the barrel is emptied. Removal requires using hot, strong, alkali solutions and, while this will effectively remove the KHT crystals, it also will remove valuable wood extractives. For these reasons, winemakers who intend to cold stabilize their wines should do so before the wine is placed in barrels for aging.

Other clarifying and fining agents

Under some circumstances using other clarification or fining agents may be desirable. However, their use requires filtration for removal, a process possible for those not intimidated by filtration equipment and operations. It should be mentioned that all materials, previously discussed and those following, have been legally approved for use in commercial wine production, and home winemakers, therefore, should be confident they are safe.

Some wines may develop tastes considered too astringent or bitter. This is usually related to excessive amounts of certain tannins, as when red wine is left too long on the skins and seeds. Gelatin treatment has been successfully used to reduce astringency and is used in very small amounts, that is, 4 to 8 ounces per 1,000 gallons. Adding egg whites has also been used to "soften" wines that taste "rough." Because they are proteins, do not use either agent after a wine has been previously protein stabilized. Alternatively, gelatin and/or egg white can be followed by bentonite fining.

Excessive amounts of certain polyphenolic compounds in white wine can lead to browning or cloudiness. One treatment for browning calls for the polymeric resin polyvinylpyrrolidone (PVPP), also known as Poly-Clar AT. This adsorbent resin is expensive, but is added in very small quantities, and is removed by racking or filtration. Poly-Clar AT will probably remove more tannin than gelatin and does not need to be followed with bentonite fining.

Activated carbon or charcoal is useful in removing undesirable odors and flavors and off-color in white wines. However, it can impart other off-tastes and/or remove desirable components, and therefore should be used cautiously. From 1 to 20 lb/1,000 gal (120 to 2,400 mg/L) are usually added directly, followed by about 2 lb/1,000 gal (240 mg/L) of bentonite, and finally by racking or filtration.

Other clarifying agents, such as Klear-Mor and Sparkeloid, may be helpful with wines difficult to clarify just before bottling. Again consult your home wine shop. Further information about fining agents may be found in *The Technology of Wine Making* (see Selected References).

Wine filtration

Most persons making wine at home would not want to go to the expense or effort involved in wine filtration, and by and large it is not necessary. However, advances in filtration technology offer the serious home winemaker reasonably affordable small-scale equipment and relatively simple techniques. Filtration facilitates wine clarification, can follow fining or aeration, and can also remove yeast and/or bacteria.

Depending upon the objective, there are three major kinds of filtration that relate to the size and amount of particles to be removed from the wine: rough, tight or polish, and microbiological. For home wine making there is now available a series of cartridge-type filters of several sizes, designed to meet the needs of all three objectives. Sheet or pad filters are less expensive. Both are either gravity-flow (quite slow) or pressure-flow (rapid). Rough filters are used to hasten wine clarification, thus reducing the number of rackings, or to filter wine from fining agents, such as bentonite lees. They may involve using a filter aid, such as diatomaceous earth (DE). Tight filtration media, used to polish filter wines before bottling, will remove most yeast cells. It is necessary to polish filter a wine before using a "microbiological" or membrane filter to remove yeast and bacteria—this latter application is useful to the winemaker who does not want the malolactic fermentation. Further information on filters, filter housings, their use and prices, can be obtained from suppliers listed at the end of this publication.

6

Analyzing Juice and Wine

Several constituents in grape juice and wine must be measured to help the winemaker make decisions throughout wine making. For example, knowledge of the soluble solids ($^{\circ}$ Brix) content of a given juice will indicate whether adding sugar may be necessary. Knowing the amount of sulfur dioxide in a wine, as well as its pH, can serve as the basis for determining the amount that may be needed for adjusting SO_2 . A paper chromatograph without a developed malic acid spot, but showing a lactic acid spot, can be evidence that a particular wine had undergone malolactic fermentation (see malic acid analysis below). Although it is possible to make wines without analysis, consistent production of sound, superior quality wines is enhanced considerably with accurate analytical data.

Many suppliers sell the chemicals and equipment or kits/assemblies, along with instructions, required to perform all of the common juice and wine analyses. However, the reliability of these materials can vary.

Therefore, exercise caution in selecting the supplier(s) of reagents, equipment, and instructions. Certainly, the ambitious and serious winemaker would find *Methods for Analyses of Musts and Wines* valuable (see Selected References).

Wine acidity and pH

Because of their importance, the acidity and pH of grapes and wine are discussed first. Earlier, the acid composition of grapes was said to directly affect wine quality and pH also played an important role in wine quality and stability. As previously mentioned, grapes and wine owe their acid composition and taste primarily to the presence of tartaric and malic acids (lactic acid replaces malic in wines that have undergone malolactic fermentation). These fruit acids are defined as weak acids, compared with such strong mineral acids as sulfuric and hydrochloric. In solution, strong acids

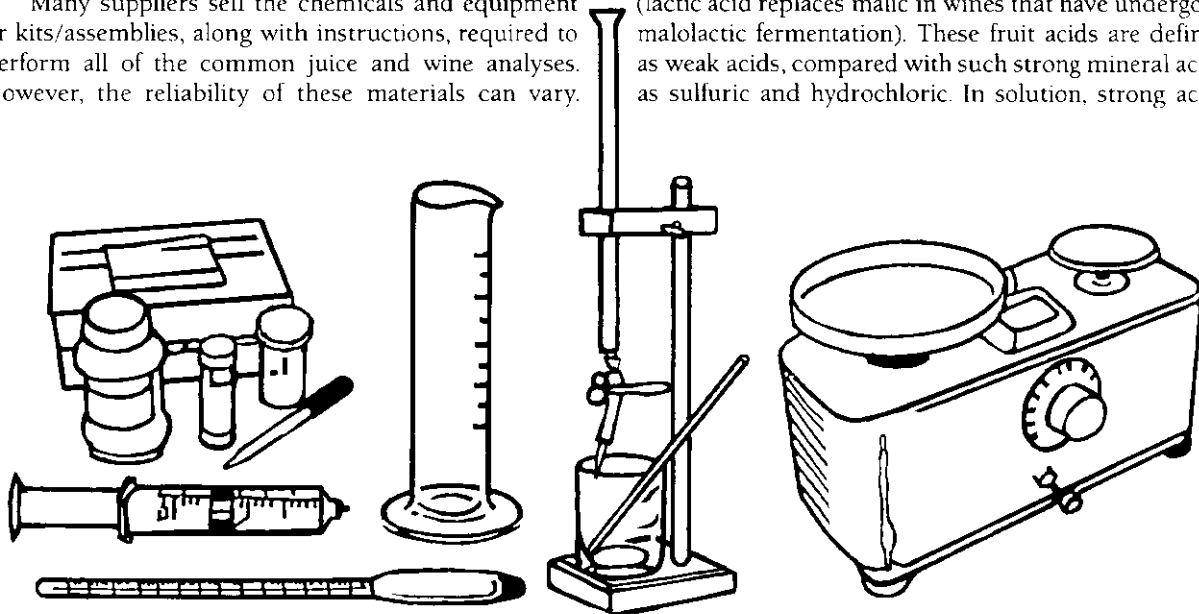

tend to dissociate or yield their hydrogen ion (H^+) component nearly completely; weak acids dissociate only about 1 percent or less of their hydrogen ions. Aqueous solutions owe their acidity or alkalinity to the ratio of hydrogen ion content to hydroxyl ions (OH^-). Thus, such acid solutions as wine have more H^+ ions than OH^- ions.

A solution's pH is a measure of the concentration of H^+ ions of an acidic solution, such as grape juice or wine, or conversely the concentration of OH^- ions of an alkaline solution, such as lye. Because the numerical values for the H^+ ion concentration are often extremely small fractions, say $1/10,000,000$ (equals 1×10^{-7}), the pH unit is used to express this concentration. A pH unit has been defined as the *negative of the logarithm* (or log of the reciprocal) of the H^+ ion concentration. The arbitrary term pH is thus a logarithmic index, employing small numbers, to express this ion concentration. As an example, in the case of distilled water, it means that 1×10^{-7} grams of H^+ ions in 1 liter has a pH of 7, where 7 is the logarithm of 10,000,000. The pH scale extends from 0 to 14, with 7 being the point of neutrality, wherein there exists the same concentration of H^+ and OH^- ions.

The important thing to note about the pH scale is that the lower the numerical value, the higher the concentration of H^+ ions and hence the higher the degree of acidity. Thus, there is an *inverse* relationship between decreasing pH units and increasing H^+ ion concentration. Note also, that because pH units are on a logarithmic scale, wine at pH 3.0 is 10 times more acidic than wine at pH 4.0—that is, there is a tenfold change in acidity for each unit change in pH. Since the pH of most table wine ranges from 3.1 to 3.6, it should be evident from the foregoing that very small numerical changes within this pH range actually reflect significant changes in wine acidity. Finally, it should be stressed that pH can profoundly affect microorganisms (low pH inhibits acetic acid bacteria and malolactics), the ratio of free to bound SO_2 , both protein and KHT stability, and wine color and flavor.

With pH defined and its importance established, how is it measured? The preferred method employs an ion-selective electrode that measures hydrogen ion concentration potentiometrically. More simply stated: A pH meter is used. Until recently, pH meters have been expensive, with bench models ranging from \$400 to more than \$900. There are now available \$150 to \$200 "hand-held" pH meters, with an accuracy resolution of from 0.01 to 0.02 pH units and temperature compensation. For most home wine making needs, a determination of ± 0.05 pH unit would be satisfactory. Instructions for standardizing the instrument, supplied by the manufacturer, must be followed exactly.

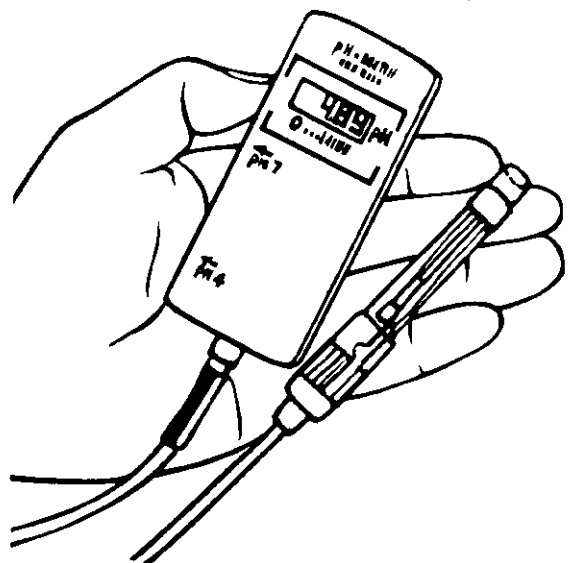

Hand-held pH meter

Even though pH can also be determined with "pH paper" (paper strips impregnated with organic dyes that produce color changes in response to various pH levels), they are not sufficiently sensitive to provide the accuracy and precision required to determine pH in grape juice or wine. Hence, we do not recommend their use for this application.

Keeping records

Maintaining accurate and complete records of all steps in wine making is vital. No winemaker can rely on memory alone for rational explanations or remedies. The serious winemaker must develop and maintain a complete chronological log for every processing activity for each wine lot produced. The wine making record book should contain:

- Date
- Time
- Wine lot identification
- Operation performed
- Juice/wine analysis data
- Amounts and kinds of sugar, acid, or other adjustments in composition
- °Brix readings of fermentation progress
- Fermentation temperature

Table 6. Corrections for Brix hydrometers calibrated at 68°F (20°C)*

Temperature in °F	Temperature in °C	Observed % sugar						
		0	5	10	15	20	25	30
		Subtract						
59.0	15	0.20	0.22	0.24	0.26	0.28	0.30	0.32
60.8	16	0.17	0.18	0.20	0.22	0.23	0.25	0.26
62.6	17	0.13	0.14	0.15	0.16	0.18	0.19	0.20
64.4	18	0.09	0.10	0.10	0.11	0.12	0.13	0.13
66.2	19	0.05	0.05	0.05	0.06	0.06	0.06	0.07
		Add						
69.8	21	0.04	0.05	0.06	0.06	0.06	0.07	0.07
71.6	22	0.10	0.10	0.11	0.12	0.12	0.13	0.14
73.4	23	0.16	0.16	0.17	0.17	0.19	0.20	0.21
75.2	24	0.21	0.22	0.23	0.24	0.26	0.27	0.28
77.0	25	0.27	0.28	0.30	0.31	0.32	0.34	0.35
78.8	26	0.33	0.34	0.36	0.37	0.40	0.40	0.42
80.6	27	0.40	0.41	0.42	0.44	0.46	0.48	0.50
82.4	28	0.46	0.47	0.49	0.51	0.54	0.56	0.58
84.2	29	0.54	0.55	0.56	0.59	0.61	0.63	0.66
86.0	30	0.61	0.62	0.63	0.66	0.68	0.71	0.73
95.0	35	0.99	1.01	1.02	1.06	1.10	1.13	1.16

*From page 80, *Official and Tentative Methods of Analysis of the Association of Official Agricultural Chemists*, 1955. Note: These corrections are satisfactory for musts and nearly correct for dry wines of low alcohol.

- SO₂ adjustments made
- Fining treatments
- Stabilization procedures performed
- Filtrations
- Aging times and in which barrels by wine lot
- Barrel cleaning treatments
- Other pertinent details.

Excessive information is better than insufficient records. Finally, when performing analyses, always record the date and how analysis is performed, any deviations from the standard procedure, and the data obtained.

Soluble solids (°Brix)

Grape juice soluble solids are composed mainly of glucose and fructose and hence are approximately equivalent to the percent sugar by weight, or grams sugar per

100 grams of solution expressed as °Brix. The °Brix of juice, must, or wine can be determined with a hydrometer or a refractometer; the refractometer cannot be used to measure the soluble solids content of wine because the presence of alcohol interferes with the reading. Because hydrometers can be used in juice or wine, a series of hydrometers covering the following or similar °Brix ranges are recommended: 19° to 31°B; 9° to 21°B; 0° to 12°B; and -5° to +5°B. Negative °Brix values (those less than zero) are due to the presence of alcohol, which depresses the specific gravity. Hydrometers are usually calibrated at 68°F (20°C) and require using a correction factor when used in juice or wine of a different temperature. Use a good quality mercury bulb chemical thermometer, one of the newer probe types, or a remote sensor thermometer with a temperature scale range of 20° to 220°F or -10° to 110°C with one-degree scale divisions and a precision of ±1°, to measure the temperature of the sample. Add or subtract the appropriate correction factor to the hydrometer reading as given in table 6.

Testing for soluble solids in juice. Fill the hydrometer cylinder with a juice sample previously clarified by allowing suspended matter to settle. Grasp the hydrometer stem and gently lower the hydrometer into the juice with a slight spinning motion. Make certain the hydrometer does not rest on the bottom or cling to the sides of the cylinder and make a reading to the nearest 0.1 °Brix after the hydrometer is freely floating and at rest. Add or subtract the appropriate temperature correction to obtain the final value.

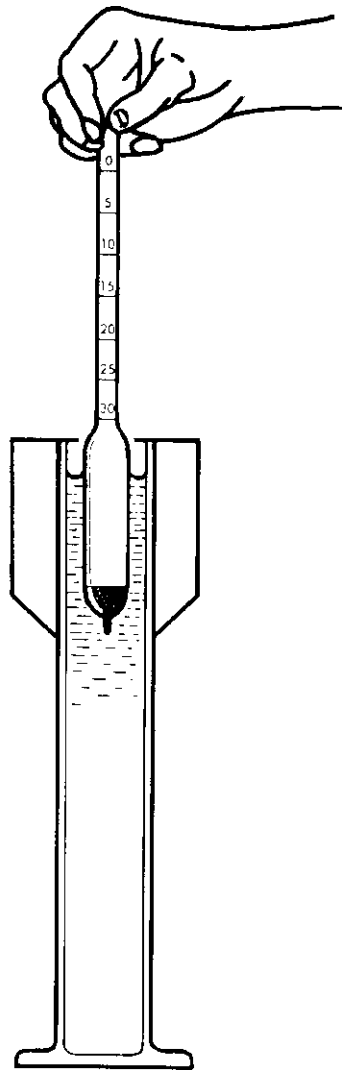

Testing °Brix in fermenting must/wine. Withdraw a sample from the fermentor and dispel most of the CO₂ bubbles with shaking. Suspend the hydrometer in the sample, as with juice, and allow to stand briefly. Use more spinning to free bubbles of gas from the hydrometer sides and make the reading.

Reducing sugar

Hydrometers are not only used to determine the sugar in juice before fermentation, but they are necessary for monitoring fermentation progress. Near the end of fermentation, when readings are less than -2° Brix (remember, minus readings occur due to the alcohol) and remain so for several days, the wine should be analyzed for reducing sugar (fermentable sugar) content to determine if the wine is, in fact, dry. A very simple and rapid tablet test (Dextrochek) can measure the sugar in the range of 0.1 to 0.2 percent. The test should be replicated at least twice. Because the tablets decompose rapidly when exposed to air or moisture, they should be kept tightly sealed. It is difficult to read the color end-point in cloudy wine; therefore, the sample should be filtered or a sample allowed to clarify by settling for a few days in a refrigerator. Red wines are also impossible to test without first removing the pigment. Decolorize the wine by adding about 1 gram (0.03 ounce, 1 to 2 teaspoons) activated carbon to 50 ml of wine, mix, filter or settle, and proceed with the test.

Titrateable acidity

As indicated in the **Introduction**, the titrateable acidity (TA) content of grapes and the wine is important to quality. Analysis for TA involves titrating a standard dilute sodium hydroxide (alkali) solution against a small juice or wine sample to a color change end-point of an indicator dye solution. Titration kits for determining TA, complete with detailed instructions, are available from home wine making shops. With care and practice, reasonably accurate and useful results can be obtained. The calculated values are expressed as tartaric acid in grams per liter. Note that the accuracy of the titration depends upon the strength of the standardized sodium hydroxide solution which, when exposed to air, loses its strength by reacting with carbon dioxide. Utilize this solution quickly or replace it with a fresh supply, daily if needed, to ensure accurate results. Accuracy can be checked by titrating against a known standardized solution of dilute hydrochloric acid, which should be part of the kit.

Total and free sulfur dioxide

As previously discussed, SO₂ is required to prevent oxidation and growth of undesirable yeast and bacteria. The usual amount added to sound crushed grapes is 50 to 100 ppm. Addition of 75 ppm SO₂ to most musts is sufficient to prevent oxygen uptake by polyphenoloxidase enzymes, which promote browning. During fermentation some SO₂ is oxidized to sulfate (SO₄²⁻) and some is bound with such compounds as acetaldehyde.

Only SO_2 that is not bound or combined is, therefore, free to provide the desired properties. When SO_2 is dissolved in water, it exists as several ionic species: molecular SO_2 , bisulfite (HSO_3^-) and sulfite (SO_3^{2-}). These forms are in equilibrium, depending upon the amount present, the pH, and temperature, in accordance with the following reactions:

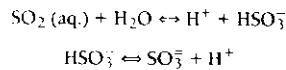

These equilibrium reactions illustrate the effect of pH, wherein it can be seen that increasing the acidity (H^+) or lowering the pH shifts the reaction to the left. It has been shown that the antimicrobial activity is the greatest for the SO_2 in the nonionized form (first formula at left in upper equation above). This further underscores the importance of low pH.

As noted, when SO_2 is added to juice or wine, it will react immediately with dissolved oxygen, the HSO_3^- with acetaldehyde (compound naturally present) and with other compounds. Also, moldy fruit has more binding sites for SO_2 . All of the bisulfite reaction products are in equilibrium with the free SO_2 and together are called total SO_2 . This fact alone renders an analysis for free SO_2 difficult, as it changes rapidly. Nevertheless, an analysis can be performed sufficiently accurately to obtain an estimate of the free SO_2 . The total SO_2 analysis seems more straightforward, since it is performed after hydrolysis of the reaction products for direct titration. It should be cautioned that red wines, because of pigment and higher tannin content, can give erroneously high results in free SO_2 determinations. Therefore, values of free SO_2 that are less than 10 to 15 ppm in white wine or less

than about 20 ppm in red wine are not considered reliable.

The preceding discussion, it is hoped, has provided some helpful background for analyzing free and total SO_2 . Titration kits that include the chemicals, equipment, and instructions for these analyses are available from home wine making shops. Although these titrations require considerably more skill than the analysis for TA, with some practice useful results should be possible. Additional instruction is contained in *Methods for Analyses of Musts and Wines* (see Selected References).

Malic acid

It can be very important to determine whether the malolactic fermentation has occurred, and the wine is therefore biologically stable. If fermentation has occurred or has been definitely inhibited, the wine can be safely bottled. Paper chromatography, a technique for qualitatively determining organic acids, is universally employed in detecting malolactic fermentation, specifically the presence or absence of malic acid. The method is simple, relatively inexpensive, and reliable. Actually, many wine-makers find this analysis fun to do. Again, home wine shops provide kits that contain equipment, chemicals, and instructions. A few words of caution: For best results, work in a clean, dry place and handle the chromatographic paper with clean dry hands to avoid contaminating the paper. Also, since the solvent is flammable and the fumes noxious and irritating, the air-drying process should be performed outdoors or in a well ventilated area, such as near an exhaust fan. (A stove hood exhaust might help, but don't leave the burners on!)

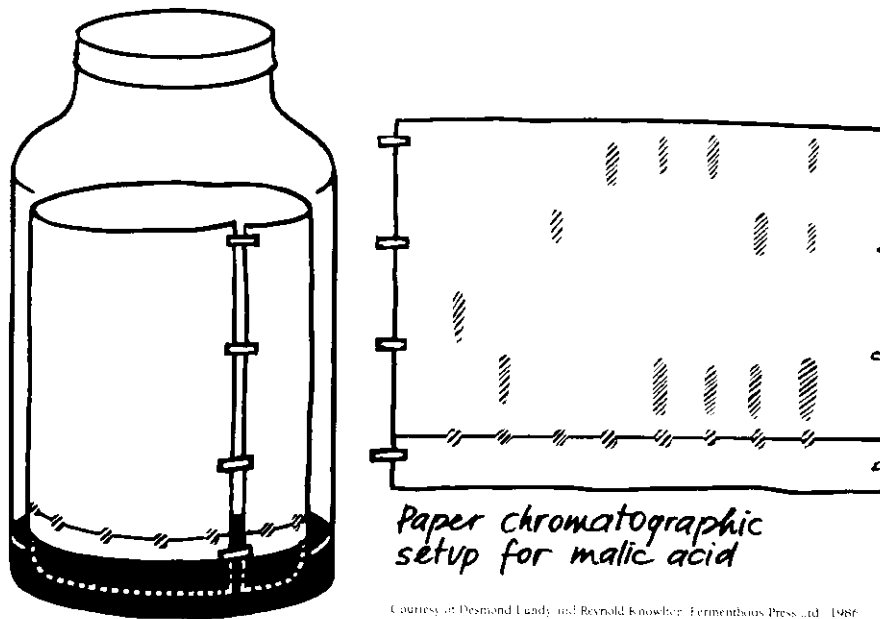

Courtesy of Desmond Lundy and Reynold Knowler, Fermentations Press, Ltd. 1986

Evaluating Wine Quality

Perhaps the most important and essential tools available to winemakers are their senses. With sight one can critically examine a wine's appearance; with smell detect pleasing and not-so-pleasing odors; with taste perceive desirable and undesirable flavors. Thus, sensory analysis not only is the ultimate test for evaluating wine quality, it is the best method for controlling quality throughout wine making.

Commercial winemakers have the formidable task of properly and reliably evaluating wine quality, as well as developing and applying an understanding of consumer taste preferences. Fortunately, hobby winemakers need only be concerned with pleasing their own tastes. Even so, certain skills are helpful, such as the ability to recognize volatile acidity, or tartness (acidity levels) and sweetness or lack of sweetness (is the wine dry or slightly sweet?). Practical methods for sharpening these kinds of tasting skills are given in *How to Test and Improve Your Wine Judging Ability* (see **Selected References**).

The ability to evaluate the overall quality of a wine is largely based upon the taster's previous experience. All judgments of wine are subjective, influenced by the

memory of wines previously tasted. Thus, wine quality is easier to recognize than it is to define. A winemaker's ability to recognize wine quality can be enhanced by frequent, regular tasting of many different wines. In addition, it is helpful, especially for the inexperienced, to taste wines, using a standardized and systematic method. Various kinds of score cards or scoring systems have been developed for this purpose. Moreover, a score card is a permanent record of the sensory analysis that can be used to compare subsequent tastings of either the same wine or other wines. One such scorecard, used for many years to evaluate wine quality, is the so-called "Davis 20-point scale," developed in the Department of Viticulture and Enology at the University of California, Davis (fig. 8). Note that the term "acescent" refers to the presence of volatile acidity or wine vinegar odor/flavor, and that space is provided on the sheet for brief narrative comments about each sample being tasted as well as scores. For a more detailed and complete discussion of wine tasting in general, and the use of score cards in particular, we recommend *Wines: Their Sensory Evaluation* (see **Selected References**).



SCORECARD

Name _____

Name or no.					
Appearance	2				
Color	2				
Aroma & bouquet	4				
Acescent	2				
Total acid	2				
Sugar	1				
Body	1				
Flavor	2				
Astringency	2				
General quality	2				
Total					

Fig. 8. According to the Davis 20-point scale, to achieve a score of 17 to 20, wines must have some outstanding characteristic and no marked defect; 13 to 16, standard wines have neither an outstanding character nor defect; 9 to 12, wines are of commercial acceptability but with a noticeable defect; 5 to 8, wines are of below commercial acceptability; 1 to 4, wines are completely spoiled.

The Wine Making Facility

The home winemaker who produces an occasional small lot of wine can perform reasonably well in the kitchen or garage. On the other hand, the serious winemaker, who plans regular involvement with larger or many small wine lots, requires more work space, equipment, wine and supply storage, and other elements that will influence success of the operation. Although much of this section relates to a bigger scale of wine making, the principles are applicable to more casual wine making.

The processing work area

The space needed to handle grapes and make wine should be separate from the area needed for aging and storage. Crushing, pressing, fermentation, racking, fining/filtration, and bottling generate considerable waste (pomace, juice or wine spills, etc.) that must be quickly and continually removed. Experience has shown that a

major portion of the time and energy spent in wine processing is devoted to cleaning and sanitizing the work area, equipment, and related utensils. Without cleanliness, it becomes difficult to function and the waste matter can serve as an ideal medium for the growth of undesirable microorganisms that infect and spoil wine. Moreover, accumulated pomace, for example, attracts vinegar flies, beetles, roaches, and other undesirable guests that are not only nuisances but are incompatible with the production of substances intended for human consumption. Thus, the processing area should have the means for disposing of solid waste and for removing liquid waste with adequate quantities of cleaning solutions and rinse water. This calls for access to hot and cold water and to a drainage-sewage system. A large deep sink equipped with faucets is adequate for small operations; larger operations are more efficient conducted on a hard surface floor (like cement) that slopes toward a sewer drain.

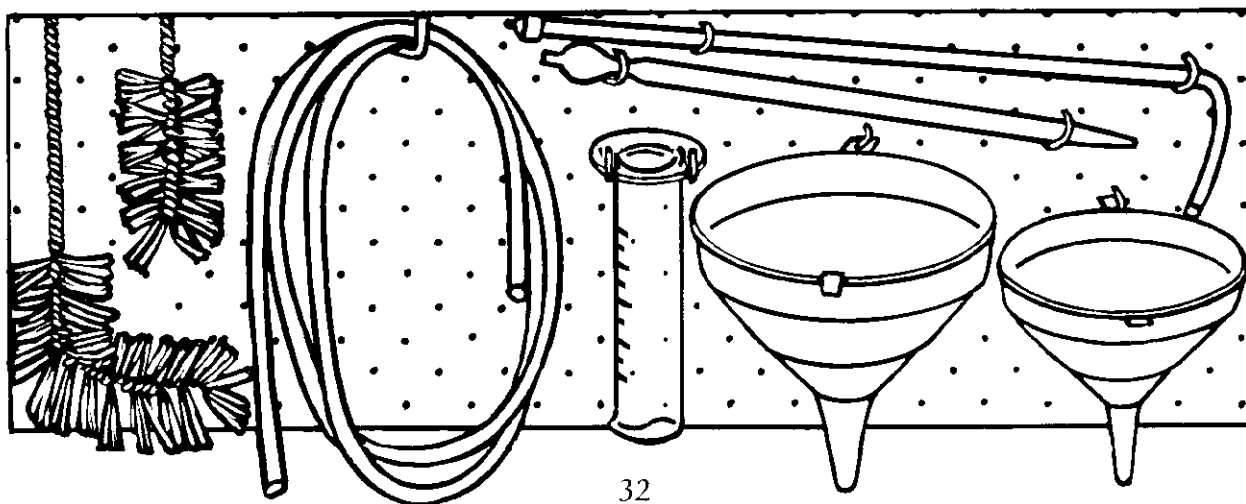



In connection with indoor operations, adequate ventilation has been mentioned as well as cooling. Such activities as crushing and pressing can be performed outdoors, as long as the juice or wine does not become too warm and the work area can be kept sanitary. Indoor work areas should have adequate lighting to facilitate wine production and cleaning. Soil that cannot be seen is not removed. Racks or other devices should be available to suspend hoses and other utensils for air drying after cleaning to avoid mold growth.

Wine aging and storage areas

Since racking and topping are performed during aging in barrels or glass containers, where leakage or spillage usually occurs, separate this activity from the area used for storage and aging of bottled wine. Temperature and relative humidity are critical to the proper aging and storage of wine. For prolonged aging times the temperature should not be above 60°F (15.6°C), preferably at 52° to 55°F (11.1° to 12.8°C). Moreover, the temperature should be as constant as possible. Variations of more than a few degrees up or down should be avoided. The most cost-effective investment for achieving adequate temperature control is insulating the walls and entrances (doors and door jambs) of storage cellars. If after insulation the desired temperature control is not achieved, then air-conditioning (refrigerated air) equipment should be installed. To make a decision, ascertain temperature fluctuations with an accurate minimum/maximum thermometer. Because warm air rises, place the thermometer at about 6 to 8 feet from the floor or at a height that can be related to the location of wine storage, to obtain representative readings. Temperature checks should be made during the warmest seasonal weather and checked daily to determine extremes.

Knowledge of the low and high temperatures, as well as the room size, is necessary for selecting the proper capacity air conditioner.

Relative humidity (RH) in the wine aging/storage areas should be between 40 and 60 percent, preferably about 60 percent in the case of barrel aging. Very dry air increases evaporation of wine during barrel aging and causes corks to shrink in bottled wines. Very moist air favors growth of mold on all surfaces, especially the outsides of barrels and corks. Besides the minimum/maximum thermometer, obtain an accurate instrument for measuring relative humidity, such as a wet bulb/dry bulb thermometer or a relative humidity meter. Should the readings indicate the need, both humidifying or dehumidifying equipment is available for home use from hardware, appliance, and department stores.

Equipment and supplies

Locate a reliable supplier for processing and laboratory equipment, utensils, and other wine making supplies. Suppliers are listed at the end of this publication. Telephone directory yellow pages often list "Winemakers' Equipment and Supplies." Some nature or health food stores and hobby or specialty shops may also carry home wine making supplies. Wherever the possibility may exist, home winemakers should consider a group purchase, especially for large equipment such as a press. In this way the expenses, as well as the use and upkeep of the equipment, are shared.

A few comments should be made about equipment design and construction. Processing equipment (crushers, presses, filters, pumps, etc.) should execute a given function efficiently without adversely affecting the quality of the wine. Equipment should be so designed as to facilitate cleaning and sanitizing. Stainless steel is the

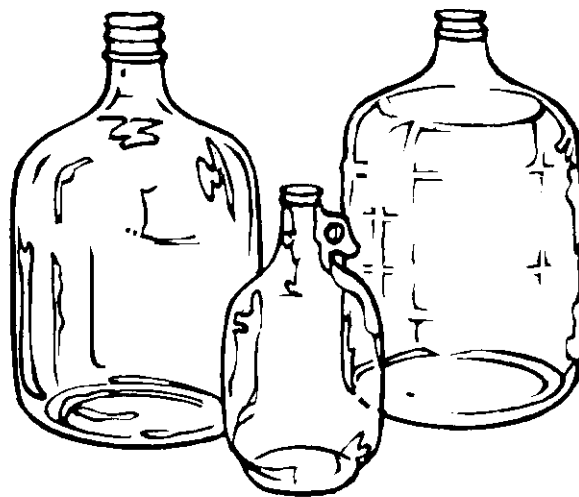

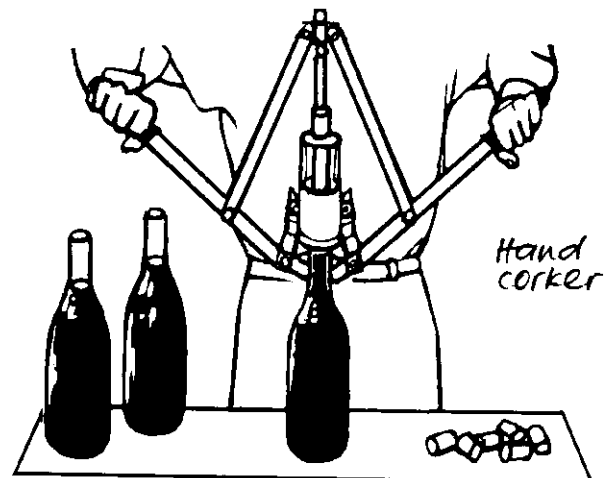
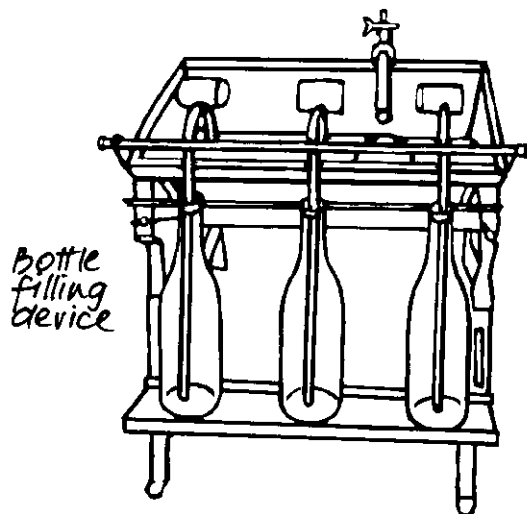

material of choice for construction of grape and wine processing equipment and related utensils. While it is usually more costly than other materials, it is very durable, easy to clean and sanitize, and, most important, it will not react with wine components or impart undesirable odors or flavors. Some equipment items are acceptable, if they are constructed of hardwood, food-grade polyethylene plastic (colorless or "virgin" plastic has not been recycled), food-grade rubber, or even glass. Do not use vinyl chloride or polyvinyl chloride (PVC) plastic containers. Suppliers and manufacturers of plastics and other materials will provide "use information" upon request. Items made of materials of unknown purity should be tested to determine if they are inert, as some materials may impart a bitter taste. Soak a sample of the material in a clean white wine of 12 percent alcohol for 24 hours; then taste the wine for off-odor or off-flavor. Obviously, glass utensils are fragile and can be dangerous if they are broken during use. However, the advantage of glass carboys, jugs, and bottles for wine storage is obvious. Plastic bottles, jugs, or carboys should not be used for wine storage or aging as they usually impart an undesirable odor and flavor to wine. Certain plastics are air permeable, and hence would promote oxidation. Other materials not recommended because they can catalyze undesirable instability are iron, bronze, brass, copper, tin, aluminum, and zinc. Mild steel is acceptable, if it is coated with an acid-resistant paint (there are certain epoxy coatings approved for food). However, such coatings often chip, leaving exposed metal, or the coating simply erodes from the surface and must be re-applied. Previous comments about equipment materials apply to any surface that may be contacted with the juice or wine, including, say, the internal parts of a pump.

Several kinds and many sizes of pumps greatly facilitate transfer of liquids during processing. The internal parts should be made of stainless steel, a tough heat-resistant plastic approved for food, or food-grade

rubber. Piston or progressive cavity pumps are the most useful for pumping semi-solid liquid (must or wet pomace), while centrifugal pumps are suggested for pumping clear juice or wine. Make sure pump seals don't leak air to avoid oxidizing the juice or wine being pumped.

Bottling and corking equipment for small-scale wine making also is available in several kinds and capacities. There are bench-top, hand-operated, floor-mounted, hand-operated or semi-automatic corking machines as well as one- or two-spout and multiple-spout, gravity-fill, bottle-siphoning devices. Remember, the simpler designs are easiest to operate, maintain, and clean. Bottling equipment surfaces in contact with wine should be made of inert materials.

Finally, because barrels are important and potentially expensive, several aspects should be stressed. White oak, the wood of choice for wine barrels, is used in making both American and European barrels. Whenever possible or affordable, buy new oak barrels rather than used ones. The risk with a used barrel is the uncertainty about past history, use, or abuse. Is it sound (doesn't leak)? Has it ever contained spoiled wine? Has it ever been used to store toxic or other undesirable substances? These are questions for which candid and dependable answers may not be available. Used barrels from wineries are usually less risky, and if they must be purchased, seek reliable sources through your home wine shop. Related to the use of wine barrels in general and, in particular, topping and bottling, is the use of oxygen-free nitrogen gas. Home wine shops can provide small cylinders of nitrogen, together with regulators and valves, to permit topping of partly filled barrels with inert gas, to replace the air. This is advantageous when topping wine is lacking or to preserve wine in a partially filled barrel during bottling, especially when it is not possible to complete bottling during a single day's operation.

Cleaning and sanitizing

The need for clean and sanitary wine making conditions is repeated here to provide additional guidance. Because there are special considerations involved, cleaning and care of wooden cooperage will be discussed separately. Practically speaking, cleaning is the removal of soil deposits (organic matter) from a surface. There are three cleaning steps: prerinsing, washing, and post-rinsing. Generally, these steps should precede sanitizing, which is, for purposes of this discussion, the reduction of potential spoilage microorganisms from a previously cleaned surface. Most cleaning tasks involve use of a lot of water, although the amount can be conserved by employing mechanical energy (scrubbing, pressure) whenever appropriate. During prerinsing and washing, do not use very hot water (170° to 180° F or above) as it will tend to “cook” the organic matter onto the surface being cleaned. Use either cold water or warm water between 120° to 140° F. Use of detergents alone or with such alkalis as soda ash and trisodium phosphate (TSP) is recommended for washing surfaces. Several small rinses, especially of fermentation vessels and other containers, are usually more effective than one large rinsing, which wastes water.

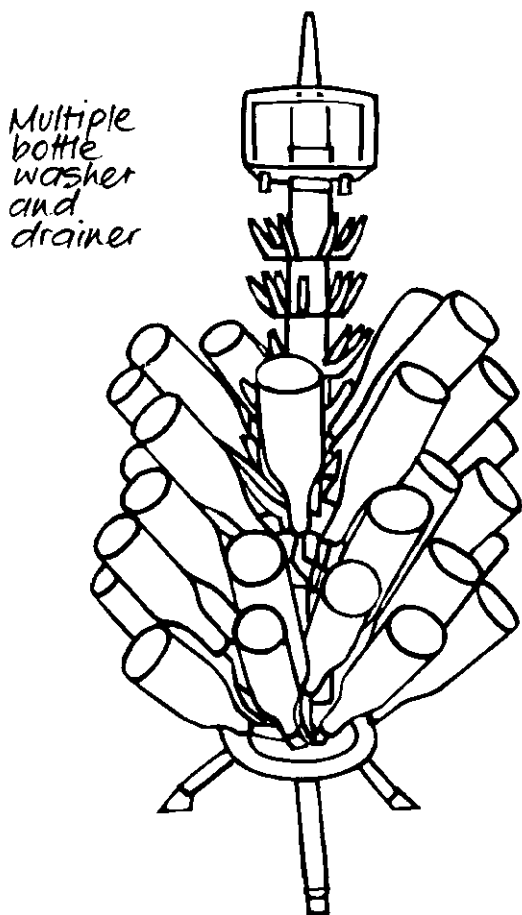

Sanitization, properly done, lowers the potential for wine spoilage organisms to develop. A good sanitizing agent is heat or hot water. In this application, the water should be about 185° F, and the surface to be sanitized must reach that temperature for 1 to 2 minutes to obtain germicidal action. An excellent alternative sanitizing agent is chlorine, readily available in ordinary household bleach. An effective solution is obtained by diluting about 1 ounce of chlorine bleach in 1 gallon of water. Higher concentrations require thorough rinsing followed by air drying to remove residual chlorine.

Cleaning and sanitizing the work area and equipment after each use should become routine. Don't neglect small items, such as rubber or plastic racking hoses and tubing, sampling and measuring utensils, mixing devices, buckets, and tasting glasses, etc. Whenever practicable, “clean as you go” to avoid a laborious and difficult cleaning period at the end of the day.

Cleaning and maintaining wooden cooperage

This discussion is concerned primarily with new and used oak barrels, but it also applies to larger wood cooperage. Oak barrels are usually expensive, and every effort should be made to keep them in near perfect condition because their primary contribution in aging wine is the oak extract they impart for a desirable aroma and flavor complexity. To benefit from this, a clean new barrel requires minimal treatment. Just rinse thoroughly, fill with acidified water (add 3.5 ounces citric acid for each 50 gallons of water), allow to soak, and check for leaks. This soaking permits the wooden staves to swell and should close small potential leaks. If the hoops were driven too tightly when the barrel was dry, the staves may collapse or warp during soaking. If there are serious problems, contact your supplier. Wine placed in untreated new oak barrels for aging must be tasted frequently to test whether there is excessive wood flavor. You may want to remove the wine after only a few days or a week. Or the wine may be left in the barrel to attain an excess level of oak and then blended with wine that has not been barrel aged. After the third filling or use, the wood extractives in a new barrel have been greatly diminished. Generally, after five fillings a barrel is considered used. Wine stored in used barrels ages but attains little oak or wood flavor.

Some winemakers feel that the taste that results from the first use of a new untreated barrel is too harsh. The barrel can be “conditioned” before using it. Oak extractives can be partially removed by soaking overnight with a solution of potassium or sodium carbonate (soda ash); use 250 grams (8.8 ounces) in 50 gallons of 140° F water. Rinse several times with water after conditioning and, if possible, refill immediately with wine.

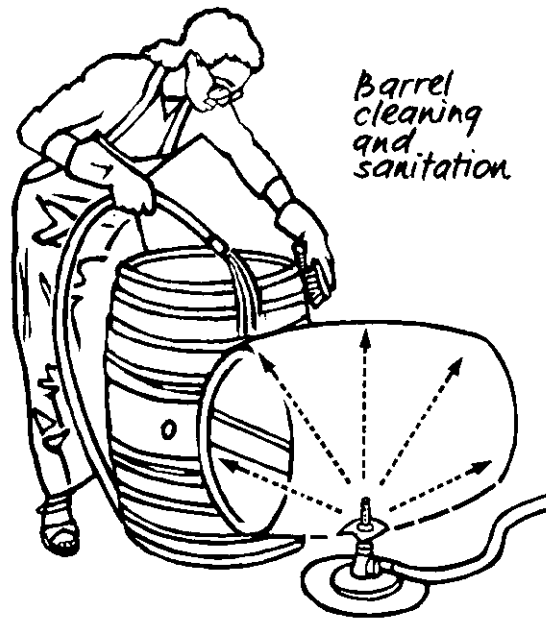

This treatment will reduce the tannin content of the new barrel by about 80 percent. This is also an accepted procedure for cleaning a barrel, especially to remove deposits of potassium bitartrate crystals that have formed inside it. In this case, longer soaking is recommended, followed by one hot and several cold water rinses, to completely remove the alkali. But remember, much of the cost of a new barrel is related to the oak flavor it possesses; hence, soda ash treatments will greatly reduce valuable flavor that could be extracted for wine quality improvement.

One problem that confronts a home winemaker is maintaining a barrel in "sweet" condition when it is not in use. The best method is to keep the barrel filled with wine. Often, unfortunately, this is not always possible. To maintain barrels for extended periods (more than 2 months) when not in use, thoroughly clean, sanitize, and air dry drained barrels; then store upside down in a clean dry place. This system, however, can lead to leaks due to shrinkage and possible buckling of the staves; therefore, several days before reuse, fill the barrels with acidified water, allow to soak, and check for leaks. For shorter periods of nonuse, fill the barrels with an acidic sulfur dioxide solution of 200 to 500 ppm to prevent

mold and spoilage yeast or bacteria from souring the barrel.

For a 50-gallon barrel, fill about two-thirds full with water; add 700 to 1,600 ml of a 10 percent $K_2S_2O_5$ solution, prepared as previously described; add 100 g citric acid (about 3.5 oz); mix thoroughly; completely fill the barrel with water; mix again and close tightly with the bung. Top the barrel and check SO_2 concentration frequently. When the SO_2 falls below about 200 ppm, replace it as often as every 2 to 4 weeks. This technique is also useful for sanitizing previously cleaned barrels just before using for wine.

Finally, once a barrel has become contaminated with spoilage organisms, such as vinegar bacteria, it is impossible to "sterilize" it. Therefore, every effort should be made to prevent contamination with a strict program of cleaning and maintenance. One common error committed in home wine making is to infect a clean barrel with a wine that is already turning to vinegar. Naturally, this renders the barrel unfit for sound wine making. Also remember: Although a barrel that has been used to age white wine can be used to age red, the reverse is not true—unless a pinkish, slightly orange, or tawny white wine is acceptable.

Afterword

Having discussed the steps required to successfully produce sound table wine at home, we offer a few words of encouragement. Home wine making is relatively easy, educational, and fun to do. Most of our guidelines are semitechnical and point out things that could go wrong. We hope that this has not been too discouraging or intimidating. The average person, starting with sound, ripe grapes, who pays sufficient attention to temperature control, avoidance of air, and sanitation, should successfully produce a pleasant tasting wine that can be enjoyed with pride. It has been observed that producing a sound wine is a skill and that making a fine wine is an art. Following the guidelines in this publication should help you to develop technical skills; experience will develop artistic skills for the pursuit of excellence in wine making.

Why make wine at home? Many reasons come to mind. We suggest that wine making is an intriguing source of personal expression that can be enjoyed according to each individual's level of interest. In a predominantly urban society, it provides an opportunity for individuals to rediscover the rhythms of nature and joy of the harvest, to participate in an experience as old as recorded history. In a time of increasing specialization and intense brain activity, wine making allows a blending of physical labor, science, and creativity. And, in a culture separated from the source of its food, wine making places the individual in the role of producer as well as consumer. As the winemaker's skills sharpen, knowledge of geography, climate, chemistry, and sensory perception will all naturally expand. Stated simply, wine is a fascinating beverage and wine making unites the mind and body with the pleasures and mysteries of a centuries old process.

Lastly, we close with our best wishes for many successful fermentations and the following thought, attributed to Benjamin Franklin:

"Wine is constant proof that God loves us and loves to see us happy."



Helpful Sources and Information

Selected References

- Amerine, M. A., et al. 1980. *The Technology of Wine Making*. 4th ed. The Avi Publishing Co., Inc., Westport, Conn. 794 pp.
- Amerine, M. A., and M. A. Joslyn. 1970. *Table Wines: The Technology of Their Production*. 2nd. ed. Univ. of Calif. Press, Berkeley and Los Angeles. 997 pp.
- Amerine, M. A., and C. S. Ough. 1980. *Methods for Analysis of Musts and Wines*. John Wiley & Sons, Inc., N.Y. 341 pp.
- Amerine, M. A., and E. B. Roessler. 1983. *Wines: Their Sensory Evaluation*. W. H. Freeman and Co., San Francisco. 432 pp.
- Amerine, M. A., and V. L. Singleton. 1977. *Wine: An Introduction*. Univ. of Calif. Press, Berkeley and Los Angeles. 2nd ed. (available in paperback). 357 pp.
- Fessler, J. H. 1971. *Guidelines to Practical Winemaking for the Modern Hobby Winemaker*. Julius H. Fessler, Berkeley, Calif. 119 pp.
- Gallander, J.J., and A. C. Peng. 1973. *Winemaking for the Amateur*. Coop. Ext. Serv., Ohio State Univ., OARDC, Wooster, Ohio. 15 pp.
- Kasimatis, A. N., Bruce Bearden, and Keith Bowers. 1977. *Wine Grape Varieties in the North Coast Counties of California*. Publ. 4069, Div. Agric. and Nat. Resources, Univ. of Calif., Berkeley. 30 pp.
- Lundy, Desmond. 1986. *Handmade Table Wines*. Fermenthaus Press, Ltd., Victoria, B.C. and Prineville, Oreg. 143 pp.
- Marcus, Irving H. 1984. *How to Test and Improve Your Wine Judging Ability*. 2nd ed. Wine Publications, Berkeley, Calif. 96 pp.
- Vine, Richard P., Gladden M. Brooks, and Jeannine Burgin. 1982. *Making Wines at Home*. Miss. Agric. and Forestry Exp. Sta. and Miss. Coop. Ext. Serv., Info. Bull. 26, Miss. State Univ. 22 pp.
- Wagner, P. M. 1976. *Grapes into Wine*. Alfred A. Knopf, N.Y. 302 pp.

Sources of Equipment and Supplies for Home Wine Making

Local firms may advertise in the yellow pages of your local telephone directory under such headings as: Hobby equipment/supplies, Wine making equipment/supplies, Home wine making supplies, etc. Additionally, health food stores, hardware stores, or crafts and hobby shops may handle selected small equipment, kits, and wine making supplies. Some pharmacies are often a convenient source for such chemicals as potassium metabisulfite, citric acid, etc. Wine making supplies and equipment firms may also be advertised in magazines about organic farming or gardening, nature or ecology, home gardening, canning, freezing, or hobby food processing. When making purchases, especially of relatively expensive items, always keep in mind the usual caveats and that price cannot always be equated with quality. No endorsement is intended or implied of the firms listed below to the exclusion of those firms not listed.

The following is a partial listing of home wine making supply firms. Contact: Home Wine & Beer Trade Association, 604 N. Miller Road, Valrico, Florida 33594, for possible location of a shop in your area.

- Barrel Builders, 1085 Lodi Lane, St. Helena, CA 94574. (707) 963-7914 or (707) 545-1708.
- Brehm Vineyard, 932 Evelyn Ave., Albany, CA 94706. (415) 527-3675.
- The Brewmaster, 2315 Verna Court, San Leandro, CA 94577. (415) 351-8920.
- Cask & Keg, 24182 Red Arrow Highway, Mattawan, MI 49071. (616) 668-2768.
- The Cellar Wine Shop, 14411 Greenwood Ave. N., Seattle, WA 98133. (206) 365-7660.
- The Compleat Winemaker, 1219 Main St., St. Helena, CA 94574. (707) 963-9681.
- Custom Chem Lab, 2127 Research Dr. #10, Livermore, CA 94550. (415) 449-4371.
- Custom Cooperage, 1194 Maple Lane, Calistoga, CA 94515. (707) 942-6902.
- De Bella's Barrel Company, 1176 Harrison St., San Francisco, CA 94103. (415) 861-1700.
- Fleming-Potter Co., Inc., 1028 S.W. Adams St., Peoria, IL 61602. (309) 676-2121.
- Fresno Home Beer & Winemaker Supply, 911 E. Belmont, Fresno, CA 93701. (209) 445-0797.
- Fun Fermentations, 640 E. Katella Ave., Orange, CA 92667. (714) 532-6831.
- Grape To Glass, 2864 Ray Lawyer Dr., Placerville, CA 95667. (916) 626-WINE.
- Great Fermentations, 87 Larkspur St., San Rafael, CA 94901. (415) 459-2520.
- Great Fermentations, 1840 Piner Rd. #14, Santa Rosa, CA 95401. (707) 544-2520.
- Michael Hat, 22335 S. Olive, Ripon, CA 95366. (209) 599-3396.
- Home Wine Making Shop, 22836 #2 Ventura Blvd., Woodland Hills, CA 91364. (818) 884-8586.
- E. C. Kraus Sales, 9001 E. 24 Highway, Independence, MO 64053. (816) 254-7448.
- Napa Fermentation Supplies, 742 California Blvd., Napa, CA 94559. (707) 255-6372.
- Napa Valley Cooperage Co., 2600 Atlas Peak Rd., Napa, CA 94558. (707) 253-7060.
- Oak Barrel Winecraft, 1443 San Pablo Ave., Berkeley, CA 94702. (415) 849-0400.
- George A. O'Brien-Winemaking Supplies, P.O. Box 284, Wayne, IL 60184. (312) 289-7169.
- O'Brien's Fermentation Supplies, 301 Spring St., Suisun City, CA 94585. (707) 425-0833.
- Petz Enterprises, P.O. Box 478, Endicott, NY 13780. (607) 758-7790.
- Presque Isle Wine Cellars, 9940 Buffalo Road, North East, PA 16428. (814) 725-1314.
- R & R Home Fermentation Supplies, 8385 Jackson Rd., Sacramento, CA 95826. (916) 383-7702.
- Scott Laboratories, Inc., 2955 Kerner Blvd., San Rafael, CA 94912. (415) 457-8460.
- Semplex of U.S.A., 4805 Lyndale N., Minneapolis, MN 55412. (612) 522-0500.
- Vinquiry, P.O. Box 1511, Healdsburg, CA 95448. (707) 433-8869.
- The Wine Lab, 477 Walnut St., Napa, CA 94559. (707) 224-7903.
- A. R. Zacher Co., 200 Santa Fe Ave., Fresno, CA 93714. (209) 485-4150.

Additional Sources of Information and Assistance

Journals, periodicals, and other publications

ANR Publications

University of California
6710 San Pablo Avenue
Oakland, CA 94608-1239

Send for the free catalog of publications of the Division of Agriculture and Natural Resources, Agricultural Experiment Station and Cooperative Extension, University of California. Publications are available on grapes, wine, and related topics. Catalogs and publications can be obtained by California residents from their county Cooperative Extension office, Public Service offices at the UC Berkeley and UC Davis campuses, or from ANR Publications.

American Journal of Enology and Viticulture

P.O. Box 1855
Davis, CA 95617

The quarterly scientific journal of the American Society for Enology and Viticulture. Primarily for professionals, but membership is also open to anyone interested in enology or viticulture and includes the journal.

California and Western States Grape Grower

Munford Publications, Inc.
3636 N. First Street, Suite 150
Fresno, CA 93726

Bimonthly magazine of semitechnical articles primarily for the vineyardist.

Practical Winery

15 Grande Paseo
San Rafael, CA 94904

A monthly magazine of semitechnical articles and trade advertising.

Vineyard & Winery Management

P.O. Box 231
Watkins Glen, NY 14891

Bimonthly trade magazine of semitechnical and popular articles and news items; emphasis upon industry in the eastern U.S.

The Vinifera Wine Growers Journal

The Vinifera Wine Growers Association
The Plains, VA 22171

Quarterly semitechnical and technical articles with association news, correspondence, and book reviews. Association membership includes the journal.

The Wine Spectator

M. Shanken Communications, Inc.
400 East 51st Street
New York, NY 10022

Semimonthly newspaper of local, national, and international trade and consumer news articles and advertising.

Wines & Vines

1800 Lincoln Avenue
San Rafael, CA 94901

Monthly trade magazine; also publishes an annual Buyer's Guide Issue that contains a listing of wineries in North America, listings of trade associations, winery/grower groups, U.S. grape crop authorities, and equipment and supply firms for the grape and wine industries.

Associations, societies, and related groups

Regional grape grower associations are located throughout the U.S. and can often assist with sources of wine grapes. Check your local telephone directory for possible listings. There are also many wine societies and other organizations that provide information, offer memberships, and hold meetings and tastings. Check your phone book for possible home wine making groups, as they cannot only be valuable sources of help but offer the opportunity for interaction and cooperative activities with other home winemakers. Finally, your local Cooperative Extension office may be a source of help in locating grapes, identifying local grape and wine organizations, provide assistance with agricultural questions, and may also have useful publications.

American Wine Society

3006 Latta Road
Rochester, NY 14612

Has regional chapters that hold meetings and wine tastings, and publishes pamphlets and a journal.

Extension courses and other educational opportunities

University of California Extension offers short courses on wine appreciation, home grape growing, and wine making. Likewise, a number of state universities, junior colleges, and community colleges also offer extension courses dealing with grapes and wine. Participa-

tion in state, county, and local wine judging competitions specifically held for home winemakers can be a valuable learning experience.

Society of Wine Educators
132 Shaker Road, Suite 14
East Longmeadow, MA 01028

National organization of persons who teach college and university courses on wine. Can provide information about wine courses and their location.

University Extension
University of California
Davis, CA 95616

Offers short courses on home wine making, with lectures, demonstrations, and hands-on production. Maintains a mailing list for course announcements.

Wine Institute
165 Post Street
San Francisco, CA 94108

Trade organization for California wineries. Offers a correspondence course on wine appreciation and publishes a tour guide to California wineries. Visiting small wineries can provide additional insight into methods and equipment appropriate to small scale wine making operations.

Federal Regulations Pertinent to Home Wine Making

Title 27—Alcohol, Tobacco Products and Firearms—of the Code of Federal Regulations.

CHAPTER 1—BUREAU OF ALCOHOL, TOBACCO AND FIREARMS, DEPARTMENT OF THE TREASURY
[T.D. ATF-55] Effective Date: February 1, 1979.

PART 240—WINE

Subpart Y—Tax-Free Production Wine for Personal or Family Use

§240.540 Production.

(a) Any adult may produce wine, without payment of tax, for personal or family use and not for sale. An adult is any individual who is 18 years of age or older. However, if the locality in which the household is located requires a greater minimum age for the sale of wine to individuals, the adult shall be that age before commencing the production of wine. This exemption does not authorize the production of wine for use contrary to State or local law.

(b) The production of wine per household, without payment of tax, for personal or family use shall not exceed:

- (1) 200 gallons per calendar year if there are two or more adults residing in the household, or
- (2) 100 gallons per calendar year if there is only one adult residing in the household.

(c) Partnerships except as provided in §240.730, corporations or associations shall not produce wine, without payment of tax, for personal or family use.

§240.541 Removal of wine.

Wine made under §240.540 may be removed from the premises where made for personal or family use including use at organized affairs, exhibitions or competitions, such as homemaker's contests, tastings or judging. Wine used under this section shall not be sold or offered for sale.

Subpart H—Other Tax-Free Removals

§240.730 Removal for personal or family use.

Any adult, as defined in §240.540, who operates a bonded wine cellar as an individual owner or in partnership with others, may remove wine from the bonded wine cellar without payment of tax for personal or family use. The amount of wine removed for each household, without payment of tax, per calendar year may not exceed 100 gallons if there is only one adult residing in the household or 200 gallons if there are two or more adults residing in the household. Wine removed in excess of the above limitations shall be reported as a taxable removal. All quantities of wine removed shall be entered as a removal on the monthly report, Form 702.

(Sec. 201 Pub. L. 85-859, 72 Stat. 1331, as amended (26 U.S.C. 5042))

Glossary

Acetaldehyde.	A natural volatile constituent in grapes and wine present in small amounts in sound table wine and in high amounts in oxidized wine.	Cap.	Grape solids (skins and pulp) that separate from juice of crushed grapes (must) and tend to float and compact on the juice surface.
Acetification.	Formation of acetic acid, as in vinegar formation.	Chaptalization.	Adding sugar to must or juice before fermentation to make up for deficiencies.
Amelioration.	Addition of water, sugar, acid, or any combination of them, to correct excesses or deficiencies in juice or must.	Chromatography.	An analytical procedure used to qualitatively separate and identify various compounds; used in wine making to determine malic and lactic acids.
Amino acids.	Natural constituents in grapes and wines that contain nitrogen and are metabolized to form protein and other compounds.	Cold stabilization.	Removal of excess potassium bitartrate to prevent its crystallization and precipitation in wine stored under cold conditions.
Aroma.	Those odors in wine primarily derived from the grape.	Concentrate, grape.	Refers to concentrated grape juice, in which the water content has been reduced so that the soluble (dissolved) solids are increased threefold; usually is 68° to 70° Brix.
Bentonite.	A clay used as a fining agent for protein removal to achieve heat stabilization or to aid in removal of fining agents.	Crusher.	Device for breaking grape berry skins to permit juice extraction.
Bisulfite, bisulfite ion.	A source of sulfur dioxide.	Crusher-stemmer.	Device for breaking grape berry skins and removing stems.
Bouquet.	Those odors in wine related to processing, such as fermentation, wood aging, bottle aging, etc.	Deacidification.	Reduction of the titratable acidity in juice, must, or wine.
Brix, ° Brix, degrees Brix.	Value used to express the weight in grams of sucrose dissolved in 100 grams of a solute, such as grape juice.	Dry, dryness.	Terms that denote absence of fermentable sugar, as in a dry wine; complete fermentation.
Browning.	Undesirable brownish (amber, tawny, dark yellow) color change in table wine resulting from oxidation.	Ethanol, ethyl alcohol.	One of the two major products of grape sugar fermentation.

Fermentation (alcoholic).	Conversion of grape sugar by yeast to ethanol and carbon dioxide.	Metabisulfite, potassium.	A solid form or source of sulfur dioxide with the chemical formula, $K_2S_2O_5$.
Fermentation trap.	Device that allows escape of carbon dioxide gas and prevents entrance of air through the opening of a fermentor.	Must.	Crushed grape mixture that contains juice, skins, seeds, and pulp.
Fermentor.	Vessel used to conduct fermentation.	Oxidation.	Process whereby grape juice or wine constituents react with oxygen, resulting in undesirable odor and flavor changes.
Fining, fining agent.	The addition of various materials that remove certain wine constituents for improved wine quality or stability, such as bentonite, gelatin, etc.	pH.	Denotes the hydrogen ion activity or concentration of hydrogen ions in an aqueous solution.
Free-run.	Juice or wine that separates freely from grape solids without the use of mechanical or other energy.	Phenolic, polyphenolic.	Naturally occurring compounds in grapes and wine (for example, tannin); important in flavor and involved in many complex wine aging and related reactions.
Free SO₂.	Sulfur dioxide ions in solution that are not chemically bound to other chemicals in solution, but that are free or available to react with such substances as dissolved oxygen, acetaldehyde, etc.	Polyphenoloxidase.	Enzyme(s) in grape juice that catalyze oxidation and browning.
Fructose.	One of two simple fermentable sugars present in grapes.	Pomace.	Mixture containing grape skins, seeds, and pulp.
Glucose.	One of two simple fermentable sugars present in grapes.	Press, pressing.	Device for separating grape juice or wine from grape solids.
Heat stability, stabilization.	Removal of excess amounts of certain protein fractions to prevent haziness or cloudiness in wine stored under warm conditions.	Press-juice/wine.	The juice or wine that is separated from grape solids by pressing.
Hydrometer.	Instrument used for measuring dissolved solids such as sugar or °Brix of solutions, such as grape juice or wine.	Pumping over.	Process for mixing juice with skins in red wine fermentation; involves pumping juice from under the cap over the cap surface to facilitate color extraction.
Lactic acid.	A weak organic acid, produced by lactic acid bacteria from malic acid.	Punching down.	Process for mixing juice with skins in red wine fermentation; involves pushing or submerging the cap downward into the juice to facilitate color extraction.
Lees.	The sedimented residue of wine fermentation, comprised mostly of spent yeast cells and small grape particulate matter.	Rack, racking.	The siphoning of clear juice or wine from sedimented solids.
Malic acid.	One of several organic acids present in grapes.	Reducing sugar.	Those sugars in juice or wine that will reduce copper upon chemical analysis and are the fermentable sugars; thus, a method for measuring the sugar content of grapes and wine.
Malolactic fermentation.	Conversion of malic acid in wine into lactic acid and carbon dioxide by certain lactic acid bacteria.	Soluble solids (dissolved solids).	Those constituents of grapes or wine that are dissolved or in solution; mostly grape sugar. Usually expressed as percent by weight (grams per 100 grams) or °Brix.

Stemmer, stemming.	Device for or process of separating grape stems from berries.	Tartaric acid.	Principal organic acid of most <i>vinifera</i> grapes.
Stuck fermentation.	The cessation of fermentation, with fermentable sugar remaining.	Titrateable acidity.	The concentration of organic acids in juice or wine, as determined by titration with a standardized dilute alkali solution, and expressed as grams tartaric acid per liter.
Sulfur dioxide, SO₂.	An antiseptic for inhibiting spoilage microorganisms in wine making. Also acts as an antioxidant. Used universally as a wine preservative and sanitizing agent.	Topping, topping-up.	Process of keeping containers of wine filled to the top or opening/closure of a wine container by adding wine.
Sweet condition.	Sweet smelling or tasting as in pure water or in wine barrels that are free of moldiness, sourness, vinegar, or other undesirable spoilage odors or flavors.	Total SO₂.	The concentration of SO ₂ in juice or wine that is the total of free SO ₂ and SO ₂ bound or combined with other compounds, e.g., acetaldehyde.
Tannins.	Phenolic compounds naturally occurring in grapes and wines; responsible for astringency and/or bitter flavors in wine.	Ullage.	The empty space that develops in bottles or casks as wine evaporates.